

CADD[®]

**CADD[®]-Solis VIP
Ambulatory Infusion Pump**

Technical Manual

Model 2120

smiths medical

The issue date of this Technical Manual is included on the back cover. In the event one year has elapsed between the issue date and product use, contact Smiths Medical to see if an updated revision of this manual is available.

Technical Assistance

For detailed instructions, specifications, warnings, warranties, and additional information on operating the CADD[®]-Solis VIP ambulatory infusion pump, refer to the Operator's Manual supplied with the product.

Smiths Medical is available to help with the programming and operation of the CADD[®]-Solis VIP ambulatory infusion pump. If you have comments or questions, call the number given below. When calling, specify the pump's software version number. This information is located in the Device Information Report (see the *Reports* section in the CADD[®]-Solis VIP Operator's Manual for more information).

Your facility may load a unique single protocol or protocol library on the CADD[®]-Solis VIP ambulatory infusion pump. When a pump is returned to Smiths Medical for service, the protocol or protocol library may be cleared as part of the service or repair process. If this occurs, the pump will be labeled with a sticker indicating the change. Before returning the pump to use, follow your facility's policies and procedures to load the correct protocol or protocol library back onto the pump. If necessary, contact your CADD[®]-Solis administrator or Smiths Medical for assistance.

U.S. Distribution:

Smiths Medical ASD, Inc.

St. Paul, MN 55112 USA

1 800.258.5361 (USA)

1 214.618.0218

www.smiths-medical.com

European Distribution:

Smiths Medical International Ltd.

TN25 4BF, UK

+44 (0) 1233 722100

Australian Distribution:

Smiths Medical Australasia Pty. Ltd.

61 Brandl Street

Eight Mile Plains, QLD 4113, Australia

+61 (0) 7 3340 1300

Table of Contents

Technical Assistance 2

Introduction 4

Limited Warranty4

Warnings4

Cautions5

Pump Overview 6

Delivery Modes6

 PCA Delivery Profile6

 Continuous Delivery Profile6

 Intermittent Delivery Profile7

 Step Delivery Profile7

 Taper Delivery Profile7

Pump Diagram8

PCA Delivery Mode Scroll Ranges9

Specifications (Nominal)11

 General Pump Specifications11

 Delivery Specifications14

 Remote Dose Cord 16

Batteries 17

Recommended Batteries17

Replacing the Battery Door17

CADD®-Solis Rechargeable Battery Pack17

Battery Storage17

Battery Life17

Collect Separately 20

Construction 21

Pumping Operation 22

Battery Backed RAM 22

LCD Circuitry 22

LED Status Indicators 22

Audible Alarm Circuitry 22

Power Circuitry 22

Battery Status 23

Pumping Mechanism 23

Pumping Characteristics 24

 Cassette “Type” Sensor Circuit 24

 Latch/Lock Sensor Circuit 24

Hardware and Software Fault Detection 25

System Fault Alarm 25

 Order of System Fault Alarm Events 25

Cleaning Procedures 26

Cleaning Solutions 26

Cleaning the Pump and Accessories 26

Annual Inspection and Testing Procedures 27

Inspection Recommendation 27

I. Visual Inspection 27

II. Mechanical Inspection 27

III. Functional Testing 28

IV. Occlusion Pressure Range Tests 33

V. Accuracy Tests 35

Pump Cleaning and Functional Testing Checklist 39

Introduction

This Technical Manual is applicable only to the model 2120 CADD[®]-Solis VIP ambulatory infusion pump. It is intended to provide a basic but limited understanding of the mechanical and electrical operation of the CADD[®]-Solis VIP ambulatory infusion pump to people familiar with the device. It also outlines cleaning and functional testing procedures that can be performed on the pump. The CADD[®]-Solis VIP Operator's Manual should be used in conjunction with this manual for complete information.

IMPORTANT NOTICE:

CADD[®]-Solis VIP ambulatory infusion pump operations and safety features are based on a microcomputer design. Inadequate servicing or tampering with the safety features of the pump may seriously affect performance and safety. For that reason, ALL SERVICING AND REPAIR OF THE CADD[®]-SOLIS VIP AMBULATORY INFUSION PUMP MUST BE PERFORMED BY SMITHS MEDICAL OR ITS AUTHORIZED AGENTS.

The manufacturer's warranty agreement shall become null and void if the pump is not used in accordance with the Operator's Manual and Instructions for Use provided with the pump accessories; or if the pump is serviced by anyone other than Smiths Medical or those authorized by Smiths Medical.

Limited Warranty

The limited warranty associated with the CADD[®]-Solis VIP ambulatory infusion pump can be found in the product literature supplied with the product when originally purchased, which is incorporated herein by reference. SMITHS MEDICAL SPECIFICALLY DISCLAIMS ANY OTHER WARRANTY, WHETHER EXPRESS, IMPLIED OR STATUTORY, INCLUDING, WITHOUT LIMITATION ANY IMPLIED WARRANTY OF MERCHANTABILITY OR FITNESS FOR USE. Smiths Medical further disclaims any responsibility for the suitability of the system for a particular medical treatment or for any medical complications resulting from the use of the system.

The manufacturer shall not be responsible for any incidental damages or consequential damages to property, loss of profits, or loss of use caused by any defect or malfunction of the system.

If you wish to receive additional information about the extent of the warranty on these products, contact your Smiths Medical representative or call Customer Service at 1 800.258.5361 (USA) or +1 214.618.0218.

All recommendations, information, and literature supplied by Smiths Medical with respect to the CADD[®] product line are believed to be accurate and reliable, but do not constitute warranties. No agent, representative, or employee of Smiths Medical has authority to bind Smiths Medical to any representation or warranty, expressed or implied.

Warnings

- The user should ensure that the performance offered by the pump is fit for the intended use and that the pump is not used in any way or for any purpose other than its intended use.
- If the pump is dropped or hit, inspect it for damage. Do not use a pump that is damaged or not functioning properly. Contact Smiths Medical Customer Service to return a pump for service.
- Do not use rechargeable NiCd or nickel metal hydride (NiMH) batteries. Do not use carbon zinc ("heavy duty") batteries. They do not provide sufficient power for the pump to operate properly.
- Always check the battery compartment for fluid or debris before inserting the batteries, and do not allow any fluid or debris to fall into the battery compartment. Fluid or debris in the battery compartment may damage the battery contacts, and could result in loss of power and nondelivery of drug.
- Residential/facility wiring must comply with all applicable electrical codes. Do not bypass power cord connections. Do not remove a prong from the power cord.
- Ensure that the $\pm 6\%$ system delivery accuracy specification is taken into account when programming the pump and/or filling the reservoir. Failure to do so may result in medication in the reservoir becoming depleted sooner than expected.

- System delivery inaccuracies beyond $\pm 6\%$ may occur as a result of back pressure or fluid resistance, which depends upon temperature, drug viscosity, catheter size, extension set tubing (for example, microbore), in-line components (such as filters and needleless access connectors), and placing the infusion reservoir and/or pump above or below the level of the patient. System delivery inaccuracy may result in under or overdosing of medication.
- There are potential health hazards associated with improper disposal of batteries, electronics, and contaminated (used) reservoirs and extension sets. Dispose of used batteries, reservoirs, extension sets, and other used accessories, or a pump that has reached the end of its useful life, in an environmentally safe manner, and according to any regulations that may apply.
- Ensure that debris is not allowed to build up on the pressure plate surface of the pumping mechanism. Inspect the air detector sensor slot and remove any debris. A blocked air detector sensor may not detect air present in the fluid path.

Cautions

- Do not operate the pump at temperatures below 2°C (36°F) or above 40°C (104°F) to avoid damaging the electronic circuitry.
- Do not store the pump at temperatures below -20°C (-4°F) or above 60°C (140°F) to avoid damaging the electronic circuitry. Do not store the pump with a CADD™ medication cassette reservoir or CADD® administration set attached.
- Do not expose the pump to humidity levels below 20% or above 90% relative humidity to avoid damaging the electronic circuitry.
- Do not store the pump for prolonged periods with the batteries installed. Battery leakage could damage the pump.
- Do not twist or turn the remote dose cord connector, or use any instrument to remove it from the pump.
- Inspect the AA batteries for damage or wear to the metal or plastic insulation prior to use, or after the pump has been dropped or hit. Replace the batteries if any damage is noted.
- If the power up results in an error message indicating that the protocol library was lost, do not proceed with using the pump. Follow your facility's procedures for downloading protocol libraries.
- Do not clean the pump with acetone, other plastic solvents, or abrasive cleaners, as damage to the pump may occur.
- Do not immerse the pump in cleaning fluid or water. Do not allow solution to soak into the pump, accumulate on the keypad, or enter the battery compartment, USB port, remote dose cord jack, or power jack areas. Moisture buildup inside the pump may damage the pump.
- CADD® pumps are sealed units. A broken or damaged seal will therefore be considered conclusive evidence that the pump has been misused and/or altered, which voids any and all warranties. All service and repair of CADD® pumps must be performed by Smiths Medical or its authorized agents.
- At the completion of the Downstream Occlusion Pressure Range Test 2, the pressure must be reduced to zero before detaching the cassette from the pump; otherwise, the cassette may rupture. Safety glasses should be worn while conducting or observing this test.

Pump Overview

Delivery Modes

The CADD[®]-Solis VIP ambulatory infusion pump system provides measured drug therapy to patients in hospital or outpatient settings. The CADD[®]-Solis VIP ambulatory infusion pump is indicated for intravenous, intra-arterial, subcutaneous, intraperitoneal, in close proximity to nerves, into an intraoperative site (soft tissue, body cavity/surgical wound site), epidural space, or subarachnoid space infusion.

This pump is not to be used in any intra-articular space infusion.

Epidural administration is limited to short-term infusion of anesthetics, and either long- or short-term infusion of analgesics.

Subarachnoid administration is limited to short-term infusion of analgesics.

PCA Delivery Profile

PCA (patient controlled analgesia) delivery is used for therapies that require a continuous rate of infusion, patient-controlled demand doses, or both, such as patient-controlled analgesia.

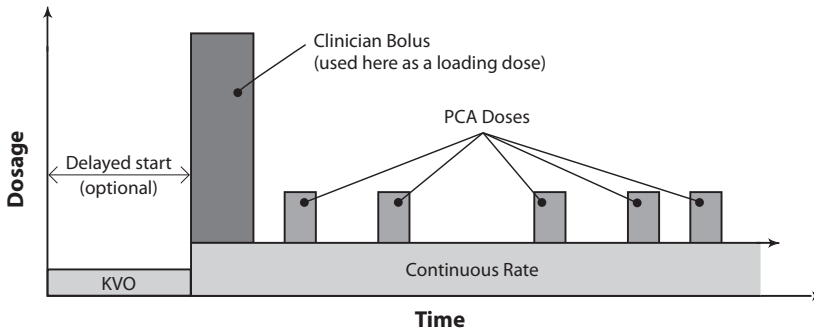

Continuous Delivery Profile

Continuous delivery allows the infusion of drug/fluid at a constant, programmed rate.

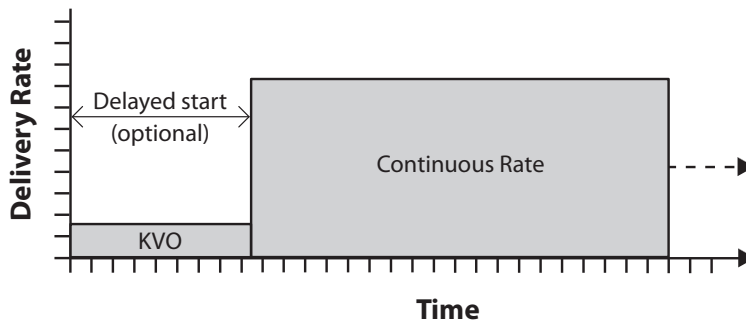

Intermittent Delivery Profile

Intermittent delivery allows the infusion of a specific volume of drug/fluid at a regular, programmed interval.

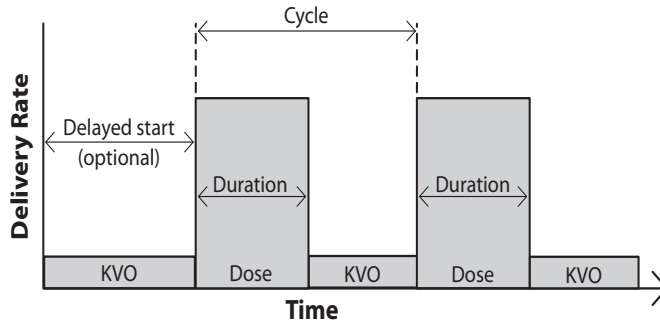

Step Delivery Profile

Step delivery allows an incremental increase in infusion rate to a specified maximum infusion rate for a specified total infusion volume.

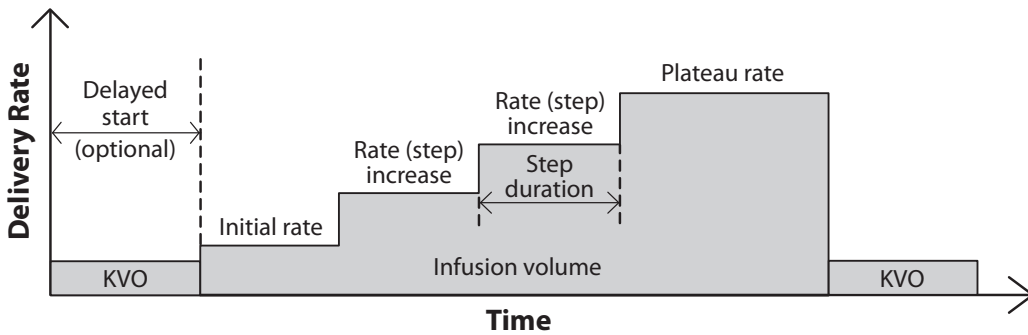

Taper Delivery Profile

Taper delivery allows a plateau rate of infusion with the option of tapering at the beginning and/or end and has a programmable KVO rate at the end of the infusion.

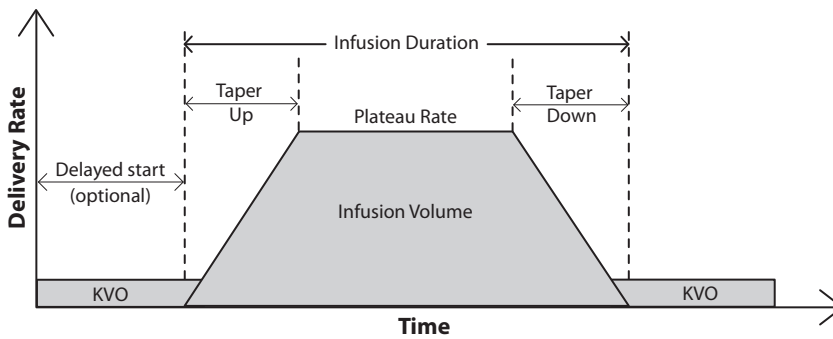

Pump Diagram

Front View

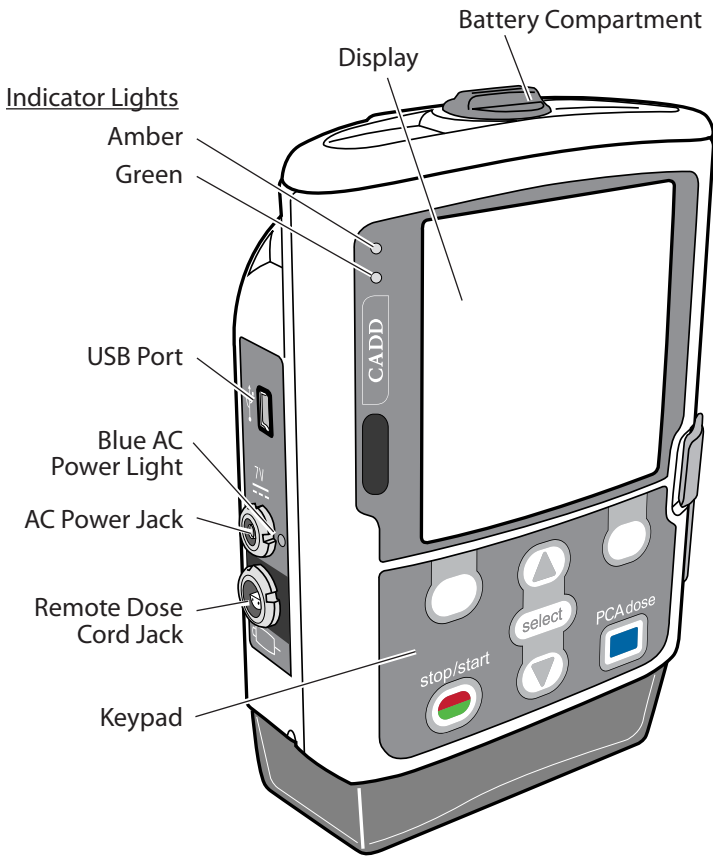

Rear View

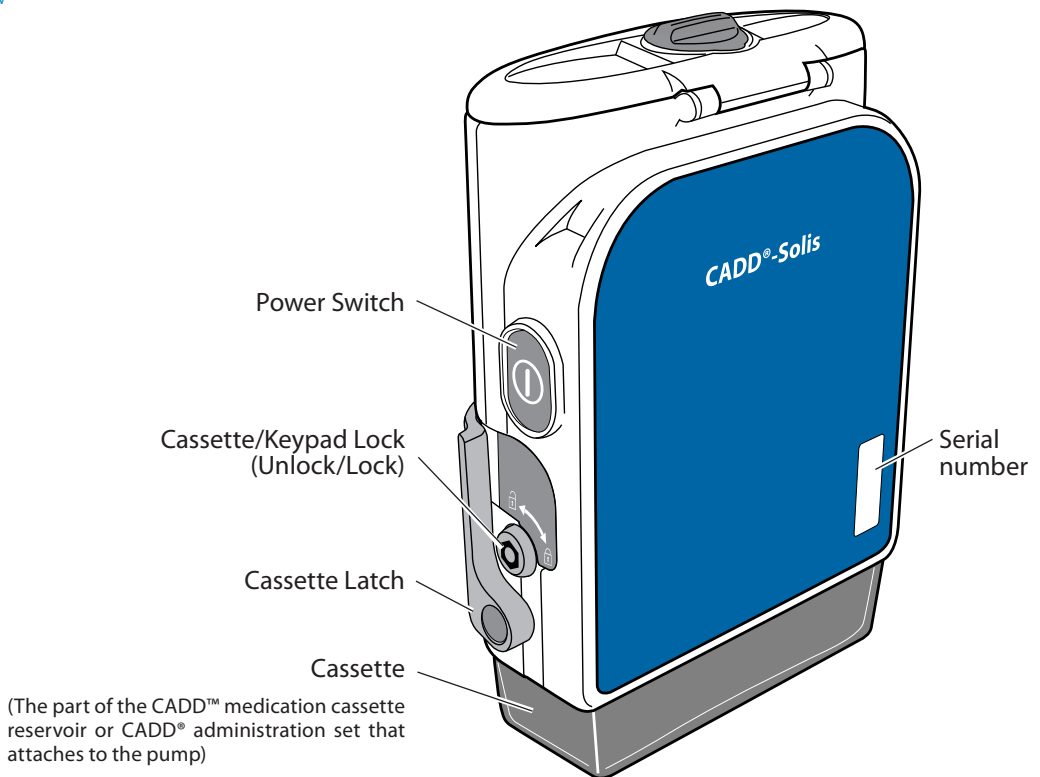

PCA Delivery Mode Scroll Ranges

PCA Continuous Rate Scroll Ranges			
Units	Starting Value	Increment	Maximum
Milliliters	0	0.10	100.00
Milligrams only	10% of concentration	Values between 0.01 and 0.5: 0.01	Concentration x 100
Micrograms only	10% of concentration	Values between 0.1 and 0.5: 0.1	Concentration x 100
Milligrams and Micrograms	10% of concentration	Values between 0.5 and 100: 0.1 Values between 100 and 1000: 1.0 Values greater than 1000: 10.0	Concentration x 100

PCA Dose and Clinician Bolus Scroll Ranges			
Units	Starting Value	Increment	Max.
Milliliters	0	0.05	50

PCA Dose and Clinician Bolus Scroll Ranges: Milligrams					
Concentration (mg/mL)	Increment (mg)	Max. (mg)	Concentration (mg/mL)	Increment (mg)	Max. (mg)
0.1	0.01	5	20	1.00	1000
0.2	0.02	10	25	1.25	1250
0.3	0.03	15	30	1.50	1500
0.4	0.04	20	35	1.75	1750
0.5	0.05	25	40	2.00	2000
1	0.05	50	45	2.25	2250
2	0.10	100	50	2.50	2500
3	0.15	150	55	2.75	2750
4	0.20	200	60	3.00	3000
5	0.25	250	65	3.25	3250
6	0.30	300	70	3.50	3500
7	0.35	350	75	3.75	3750
8	0.40	400	80	4.00	4000
9	0.45	450	85	4.25	4250
10	0.50	500	90	4.50	4500
11	0.55	550	95	4.75	4750
12	0.60	600	100	5.00	5000
13	0.65	650			
14	0.70	700			
15	0.75	750			

PCA Dose and Clinician Bolus Scroll Ranges: Micrograms					
Concentration (mcg/mL)	Increment (mcg)	Max. (mcg)	Concentration (mcg/mL)	Increment (mcg)	Max. (mcg)
1	0.05	50	35	1.75	1750
2	0.10	100	40	2.00	2000
3	0.15	150	45	2.25	2250
4	0.20	200	50	2.50	2500
5	0.25	250	55	2.75	2750
6	0.30	300	60	3.00	3000
7	0.35	350	65	3.25	3250
8	0.40	400	70	3.50	3500
9	0.45	450	75	3.75	3750
10	0.50	500	80	4.00	4000
11	0.55	550	85	4.25	4250
12	0.60	600	90	4.50	4500
13	0.65	650	95	4.75	4750
14	0.70	700	100	5.00	5000
15	0.75	750	200	10.00	10,000
20	1.00	1000	300	15.00	15,000
25	1.25	1250	400	20.00	20,000
30	1.50	1500	500	25.00	25,000

Specifications (Nominal)

General Pump Specifications

Used to test the pump	<ul style="list-style-type: none"> • CADD™ medication cassette reservoirs, [REF] 21-7002, 21-7308, 21-7302 • CADD® extension sets, [REF] 21-7045, 21-7046, 21-7047 • CADD® administration sets, [REF] 21-7091, 21-7034, 21-7021, 21-7321 • CADD® high volume administration sets, [REF] 21-7057, 21-7357
Resolution	<ul style="list-style-type: none"> • CADD™ medication cassette reservoir: 0.050 mL per pump stroke nominal • CADD® administration set: 0.050 mL per pump stroke nominal • CADD® high volume administration set: 0.1 mL per pump stroke nominal
Size	Excluding cassette and accessories: 4.1 cm × 10.2 cm × 12.7 cm 1.6 in × 4 in × 5 in
Weight	Including 4 AA alkaline batteries, excluding other accessories: 595 g 21 oz
Pump alarms	<ul style="list-style-type: none"> • High priority alarms: Air in line detected, Battery depleted while delivering, Battery removed while delivering, Battery unusable while delivering, Disposable attached improperly, Disposable detached while delivering, Disposable locked but not latched, Disposable type high flow administration set not allowed, Disposable type high flow administration set required, Disposable type invalid, Downstream occlusion, Key stuck, Pressure sensor faulty, Pump automatically stopped, Rechargeable battery end of life, Remote dose cord key stuck, Reservoir volume empty, Stop mode reminder, Upstream occlusion • Medium priority alarms: 23 • Low priority alarms: 10 • Informational messages/alerts: 23
Battery fallout alarm	Alarm sounds for 2 minutes if the pump has been powered up for a minimum of 4 minutes. Note: Alarm enabled while pump is in run mode only.
Classification	CF <input checked="" type="checkbox"/> Class II <input type="checkbox"/>
Moisture protection	Splashproof (IPX4) per IEC 60529
Maximum infusion pressure	1.86 bar 27.0 psi

Maximum time to occlusion alarm and Bolus volume at occlusion alarm	Flow Rate (mL/hr)	Tubing Set	Max. Time to Occlusion		Bolus at Occlusion	
			Raw Test Data (min)	Spec. (min)	Raw Test Data (mL)	Spec. (mL)
	0.1	CADD™ medication cassette reservoir [REF] 21-7002 with CADD® extension set [REF] 21-7045	90	≤ 160	0.107	≤ 0.25
		CADD® administration set [REF] 21-7091	122	≤ 190	0.139	≤ 0.30
		CADD® high volume administration set [REF] 21-7055	1140	≤ 1200	1.250	≤ 1.40
	Flow Rate (mL/hr)	Tubing Set	Max. Time to Occlusion		Bolus at Occlusion	
			Raw Test Data (sec)	Spec. (sec)	Raw Test Data (mL)	Spec. (mL)
	150	CADD™ medication cassette reservoir [REF] 21-7002 with CADD® extension set [REF] 21-7045	4	≤ 45	0.069	≤ 0.25
CADD® administration set [REF] 21-7091		4	≤ 45	0.072	≤ 0.30	
CADD® high volume administration set [REF] 21-7055		32	≤ 90	1.059	≤ 1.40	
Power sources	<ul style="list-style-type: none"> • AC adapter • CADD®-Solis rechargeable battery pack • Four AA alkaline batteries (for example, Duracell® PC1500/MN1500, IEC LR6) 					
Charging system for internal memory backup battery	The internal memory backup battery uses lithium manganese dioxide technology. It charges whenever the pump is powered on and has a 10-month memory capacity once it has been charged for 250 hours at 20°C (68°F).					
System operating temperature	15°C to 40°C 59°F to 104°F					
System storage and transportation temperature	-20°C to 60°C -4°F to 140°F					
Relative humidity	20% to 90% relative humidity, non-condensing					
Atmospheric pressure	70 kPa to 106 kPa 10.2 psi to 15.4 psi					

System delivery accuracy	<p>± 6% (nominal). At low infusion rates, this accuracy may not be achieved for short periods. During the total infusion time, the accuracy averages out.</p> <hr/> <p>WARNING:</p> <ul style="list-style-type: none"> • Ensure that the ± 6% system delivery accuracy specification is taken into account when programming the pump and/or filling the reservoir. Failure to do so may result in medication in the reservoir becoming depleted sooner than expected. If the pump is being used to deliver critical or life sustaining medication, the interruption in the delivery of medication could result in patient injury or death. • System delivery inaccuracies beyond ± 6% may occur as a result of back pressure or fluid resistance, which depends upon temperature, drug viscosity, catheter size, extension set tubing (for example, microbore), in-line components (such as filters and needleless access connectors), and placing the infusion reservoir and/or pump above or below the level of the patient. System delivery inaccuracy may result in under or overdosing of medication. <hr/>	
Using CADD™ medication cassette reservoirs	<p>± 6% (nominal) at 15°C to 40°C with no back pressure</p> <ul style="list-style-type: none"> • An additional ± 2.5% change may be seen at ± 100 mmHg (± 1.9 psi). 	
Using CADD® administration sets	<p>± 6% (nominal) at 15°C to 40°C with no back pressure.</p> <ul style="list-style-type: none"> • An additional ± 2.5% change may be seen at ± 100 mmHg (± 1.9 psi). 	
Using CADD® high volume administration sets	<p>± 6% (nominal) at 15°C to 40°C with no back pressure</p> <ul style="list-style-type: none"> • An additional ± 5% change may be seen at ± 100 mmHg (± 1.9 psi). 	
System definition	<p>CADD®-Solis pump with 1 of the following attached:</p> <ul style="list-style-type: none"> • Medication cassette reservoir and CADD® extension set • Medication cassette reservoir with Flow Stop feature and CADD® extension set • CADD® administration set • CADD® administration set with Flow Stop feature 	
High pressure alarm threshold	<p>1.24 bar ± 0.62 bar 18 ± 9 psi</p>	
Air detector alarm	<p>Sensitivity:</p> <ul style="list-style-type: none"> • Low: Single bubble > 400 µL • High: Single bubble > 150 µL <p>Accumulated Air: Greater than 1 mL air over 15 minutes (nominal)</p>	
Bolus accuracy specification: ± 6%	Actual test data for bolus accuracy at 0.05 mL:	
	Average	0.0508 mL
	% Error	1.6%
	Minimum Error %	-3.0%
	Maximum Error %	4.2%
	Actual test data for bolus accuracy at 50 mL:	
	Average	50.77 mL
	% Error	1.55%
	Minimum Error %	-0.07%
	Maximum Error %	2.35%
Maximum volume infused under single-fault conditions	<ul style="list-style-type: none"> • CADD® administration set: 0.15 mL • CADD® high volume administration set: 0.30 mL 	

Delivery rate during priming	<ul style="list-style-type: none"> • Standard volume administration set: approx. 250 mL/hr • High volume administration set: approx. 500 mL/hr
Alarm disabled during priming	Air-In Line

Delivery Specifications

Common Delivery Specifications	
Reservoir volume	0 to 9999 Programmable in 1 mL increments. Displayed in 0.1 mL increments.
Given	0 to 99,999.99 in 0.01 unit increments
Res vol low trip point	1 to 999 mL in increments of 1 mL
Res vol empty alarm	<ul style="list-style-type: none"> • Insistent and one time only • Non-insistent and repeating
Delayed start	0 to 96 hr in 5 min increments
Pump stopped alarm	<ul style="list-style-type: none"> • Informational • High priority
Air detector	<ul style="list-style-type: none"> • On • Off
Air detector sensitivity	Low Sensitivity: Single bubble > 400 μ L High Sensitivity: Single bubble > 150 μ L
Alarm volume	<ul style="list-style-type: none"> • High • Medium • Low
PM (preventive maintenance) reminder	Interval: 1 to 24 months in 1 month increments Enable: On or off
Custom keypad code	001 to 899 in increments of 1
Custom clinician code	001 to 899 in increments of 1
Custom administrator code	001 to 899 in increments of 1
Date format	<ul style="list-style-type: none"> • US standard (month/day/year) • European standard (day/month/year) • International standard ISO 8601:2004 (year/month/day)
Time format	<ul style="list-style-type: none"> • 00:00 to 23:59 military • 12-hour AM/PM
Downstream occlusion sensitivity	High Sensitivity: When the high pressure alarm threshold is reached, the downstream occlusion alarm is triggered immediately. Low Sensitivity: When the high pressure alarm threshold is reached, the downstream occlusion alarm is delayed for 2 seconds. This allows for the pressure to stabilize before a possible alarm. If the pressure stabilizes below the high pressure alarm threshold before the 2 second delay is complete, the alarm will not occur.

Common Delivery Specifications	
Upstream occlusion sensor	<ul style="list-style-type: none"> • On • Off <p>Note: The upstream occlusion sensor is automatically disabled during use with medication cassette reservoirs.</p>

PCA Delivery Specifications	
Programming units	<p>If programming through manual mode. Otherwise the programming units are preset through the CADD™-Solis Medication Safety Software.</p> <ul style="list-style-type: none"> • Milliliters (mL) • Milligrams (mg) • Micrograms (mcg)
Concentration	<p>mg/mL:</p> <ul style="list-style-type: none"> • 0.1 to 0.5 mg/mL in increments of 0.1 mg/mL • 0.5 to 1 mg/mL in increments of 0.5 mg/mL • 1 to 15 mg/mL in increments of 1 mg/mL • 15 to 100 mg/mL in increments of 5 mg/mL <p>mcg/mL:</p> <ul style="list-style-type: none"> • 1 to 15 mcg/mL in increments of 1 mcg/mL • 15 to 100 mcg/mL in increments of 5 mcg/mL • 100 to 500 mcg/mL in increments of 100 mcg/mL
Continuous rate	0 to 100 mL/hr (or the mg or mcg equivalent)
PCA dose	0 mL to 50 mL (or the mg or mcg equivalent) Max delivery rate (continuous rate + PCA dose): 40 to 250 mL/hr
PCA dose lockout	1 minute to 24 hours in the following increments: <ul style="list-style-type: none"> • 1 minute for values between 1 and 20 minutes • 5 minutes between 20 minutes and 24 hours
Max doses per hour	1 to 60
Delivery limit amount	0.1 to 1900 mL (or the mg or mcg equivalent) in increments of: <ul style="list-style-type: none"> • 0.01 mL from 0.1 to 0.5 mL • 0.1 mL from 0.5 to 100 mL • 1 mL from 100 to 1,000 mL • 10 mL from 1,000 to 1,900 mL
Clinician bolus	0 to 50 mL (or mg or mcg equivalent)
Delivery limit method	<ul style="list-style-type: none"> • Delivery limit • Max doses per hour • Not in use
Delivery limit period	1 to 12 hours in increments of 1 hour
Max delivery rate, combined bolus and continuous rate	40 to 250 mL/hr in increments of 1 mL
KVO rate	<ul style="list-style-type: none"> • 0 mL/hr • 0.1 mL/hr

Continuous Delivery Specifications	
Continuous rate	0.1 to 500 mL/hr
KVO rate	0.1 to 10 mL/hr

Intermittent Delivery Specifications	
Dose volume	0.1 to 1000 mL
Dose duration	1 min to 24 hr

Intermittent Delivery Specifications	
Dose cycle	10 min to 96 hr
Next dose start time	0 to 96 hr in 5 min increments
KVO rate	0 to 10 mL/hr

Step Delivery Specifications	
Initial rate	0.4 to 499 mL/hr
Plateau rate	0.4 to 500 mL/hr
Rate increment	0.4 to 499 mL/hr
Infusion volume	1 to 9990 mL
Step duration	15 min to 24 hr
KVO rate	0 to 10 mL/hr
Step infusion alerts	<ul style="list-style-type: none"> • On • Off

Taper Delivery Specifications	
Infusion volume	1 to 9990 mL
Taper up	0 min to 99:40 hr:min
Taper down	0 min to 99:40 hr:min
Infusion duration	10 min to 99:50 hr:min
KVO rate	0 to 10 mL/hr
Plateau rate upper limit	0.1 to 500 mL/hr

CADD™ Ambulatory Tubing Set Testing	
One representative medication for each of the following routes of delivery was tested for drug interaction with pump disposables. Use any selected drug in accordance with the indications included in the drug package insert. Administration of any drug by the CADD®-Solis VIP ambulatory infusion pump is limited by any warnings, precautions, or contraindications in the drug labeling.	
Route of Delivery	Drug Tested
Intravenous, subarachnoid space (intrathecal)	Morphine Sulfate Injection
Intra-arterial	Floxuridine for Injection, USP
Intraperitoneal	Dianeal with dextrose
Epidural space, local infiltration (subcutaneous, perineural, surgical site)	Ropivacaine HCl Injection

Remote Dose Cord

Smiths Medical provides a remote dose cord for use by the patient. The push button is a single pole double throw (SPDT) switch. When the remote dose cord is attached to the pump, the patient may press the remote dose cord button to receive a PCA dose. For easy access, the remote dose cord may be fastened to the patient's clothing or bedsheet with the attached clip.

NOTE: To detach the remote dose cord from the pump, grasp the remote dose cord connector and pull straight back using a straight, steady motion.

CAUTION: Do not twist or turn the remote dose cord connector, or use any instrument to remove it from the pump.

For additional specifications, refer to the instructions for use provided with the product.

Batteries

Recommended Batteries

AA 1.5 volt primary (non-rechargeable) alkaline batteries (for example, Duracell[®] PC1500 / MN1500, IEC LR6) or the CADD[®]-Solis rechargeable battery pack are recommended for use in the CADD[®]-Solis VIP ambulatory infusion pump.

Note: Smiths Medical does not recommend mixing new and used batteries; doing so may affect low battery alarm times. Always select four new batteries when replacing depleted batteries.

CAUTION: Inspect the AA batteries for damage or wear to the metal or plastic insulation prior to use, or after the pump has been dropped or hit. Replace the batteries if any damage is noted.

Replacing the Battery Door

If the battery door is removed or needs replacing, simply snap the door onto the bar that is located on the pump.

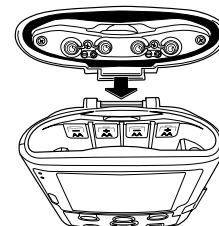

CADD[®]-Solis Rechargeable Battery Pack

The battery pack is made up of a lithium-ion cell. When fully charged, its capacity is 5.2 Wh.

Each battery pack can sustain a minimum of 500 charge/discharge cycles. Within the operating temperature range of 2°C to 40°C (36°F to 104°F), the battery pack becomes fully charged in 4 hours or less.

The battery pack can be recharged using the CADD[®]-Solis AC adapter. It can be plugged directly into the AC adapter or it recharges in the CADD[®]-Solis VIP pump with an AC adapter attached.

NOTE: Periodically inspect the rechargeable battery pack for damage or wear to the metal or plastic insulation. Discontinue use if any damage is noted.

See the instructions for use supplied with the rechargeable battery pack for more information.

Battery Storage

The CADD[®]-Solis rechargeable battery pack should not be stored in a refrigerator. Recommended storage conditions are 19°C to 25°C (66°F to 77°F).

Alkaline batteries should not be stored in a refrigerator. Recommended storage conditions are 10°C to 24°C (50°F to 75°F) with no more than 65% non-condensing relative humidity.

Battery power is quickly depleted at temperatures below 10°C (50°F). After 4 years of storage at 21°C (70°F), an alkaline battery retains approximately 86% of its original capacity. Battery life is shorter if the battery is stored above room temperature. An alkaline battery stored at 43°C (110°F) discharges to approximately 80% of its capacity within one year.

Battery Life

Battery life is dependent on the following factors:

- Programmed delivery rate
- Operating temperatures
- Frequency of use and intensity of display backlighting
- Duration of use of the USB connector
- Battery storage conditions
- Battery type and brand
- Battery age

The following tables may be used to predict typical alkaline battery and CADD®-Solis rechargeable battery pack life at different delivery rates. As expected, battery life decreases as the delivery rate increases.

<p>Alkaline battery life with screen backlight intensity set to 3</p> <p>PCA and Continuous delivery</p> <p>(Max. delivery rate = 100 mL/hr, when using the PCA delivery mode)</p>	<p>These estimates are based on laboratory tests conducted at room temperature using new batteries (Duracell® PC1500 / MN 1500, IEC LR6). Actual battery life varies depending on the battery brand, shelf life, temperature conditions, delivery rate, and frequency of screen display and backlighting. It is recommended that new batteries be kept available for replacement.</p>						
	Delivery Rate (mL/hr)		Operating Time (hrs)		Vol. Delivered (mL)		
	0.4		142		56		
	1		139		139		
	5		124		620		
	10		113		1130		
	30		69		2070		
	50		59		2950		
	125		37		4625		
	200		29		5800		
	350		15		5250		
500		11		5500			
Intermittent delivery	Volume (mL)	Duration (hr)	Cycle (hr)	KVO (mL/hr)	Operating Time (hrs)	Vol. Delivered (mL)	
	20.2	1	4	0.2	131	684	
	40.7	1	4	0.2	116	1221	
	61	1	6	0.2	111	1177	
	125	1	6	0.2	75	1637	
	200	1	12	0.2	111	2020	
Step delivery	Volume to Deliver (mL)	Starting Rate (mL/hr)	Step Duration (min)	Step Rate Increase (mL/hr)	Max Rate (mL/hr)	No. of Steps	Operating Time (hrs)
	900	45	15	45	315	7	23
	1500	37.5	30	80	300	5	24
	2500	30	30	90	300	4	19
Taper delivery	Volume (mL)	Period (hr)	Taper Up (hr)	Taper Down (hr)	KVO (mL/hr)	Operating Time (hrs)	Vol. Delivered (mL)
	2000	12	1	1	5	31	5800
	3000	12	1	1	5	23	6460

Rechargeable battery pack life with screen backlight intensity set to 3 PCA and Continuous delivery (Max. delivery rate = 100 mL/hr, when using the PCA delivery mode)	These estimates are based on laboratory tests conducted at room temperature using a new CADD®-Solis rechargeable battery pack. Actual battery life varies depending on temperature conditions, delivery rate, and frequency of screen display and backlighting. It is recommended that new batteries be kept available for replacement.						
	Rate (mL/hr)		Life (hrs)		Volume (mL)		
	0.4		74		29		
	1		67		67		
	5		60		300		
	10		50		500		
	30		40		1200		
	50		35		1750		
	125		30		3750		
	200		20		4000		
	350		13		4550		
	500		10		5000		
	Intermittent delivery	Volume (mL)	Duration (hr)	Cycle (hr)	KVO (mL/hr)	Operating Time (hrs)	Vol. Delivered (mL)
20.2		1	4	0.2	81	436	
40.7		1	4	0.2	68	702	
61		1	6	0.2	85	929	
125		1	6	0.2	53	1133	
200		1	12	0.2	95	2424	
Step delivery	Volume to Deliver (mL)	Starting Rate (mL/hr)	Step Duration (min)	Step Rate Increase (mL/hr)	Max Rate (mL/hr)	No. of Steps	Operating Time (hrs)
	900	45	15	45	315	7	17
	1500	37.5	30	80	300	5	17
	2500	30	30	90	300	4	15
Taper delivery	Volume (mL)	Period (hr)	Taper Up (hr)	Taper Down (hr)	KVO (mL/hr)	Operating Time (hrs)	Vol. Delivered (mL)
	2000	12	1	1	5	21	3830
	3000	12	1	1	5	17	4640

Collect Separately

This product contains electrical and electronic components (including batteries) that may contain materials, which if disposed of with general waste, could be damaging to the environment.

In accordance with Directive 2002/96/EC Waste Electrical and Electronic Equipment, residents of the European Union must follow specific disposal or recycling instructions for this product. Contact your local distributor, or visit the following web site for specific instructions:

<http://www.smiths-medical.com/recycle/index.html>.

Non-European Union residents must dispose of or recycle this product (including batteries) in accordance with the local laws or regulations that apply.

WARNING: There are potential health hazards associated with improper disposal of batteries, electronics, and contaminated (used) reservoirs and extension sets. Dispose of used batteries, reservoirs, extension sets, and other used accessories, or a pump that has reached the end of its useful life, in an environmentally safe manner, and according to any regulations that may apply.

Construction

The **pump housing** is made of special, high-impact plastic with an internal metallized coating designed to reduce interference from electromagnetic fields and dissipate electrostatic discharge. It is composed of 3 sections: the base, cover, and battery housing. The pump housing is sealed to ensure that the pump is water resistant.

Note: The CADD[®]-Solis VIP pump is water resistant (IPX4), but not waterproof.

The **battery compartment** is accessed through a hinged door on the top of the pump housing. Within the battery compartment is space for 4 AA batteries or the rechargeable battery pack.

A **CADD[™] medication cassette reservoir** or **CADD[®] administration set** is attached to the bottom of the pump by inserting the 2 hooks on the cassette into the mating hinge pins on the pump. The pump and cassette can be latched in place by first rotating the latching lever to the furthest downward position. With the latching lever in this position, the cassette slides smoothly into place when pushed up into the pump. The latching lever can then be rotated back up to its latched position. The cassette is locked into place by inserting a key into the pump lock and turning the lock into the locked position. The cassette must be unlocked before it can be unlatched. CADD[™] medication cassette reservoirs and CADD[®] administration sets are intended for single use only.

The **keypad**, located on the front housing, is composed of 7 membrane switches and is sealed against moisture. All the keys contain domes to provide a tactile feel when the key is pressed. The keypad keys are sensed by the pump microprocessor. The top left and top right keys are designated “soft keys,” meaning that they operate based on the messages displayed on the screen directly above them.

The **liquid crystal display (LCD)**, also located on the front housing, shows the pump status and programmed settings. The content of the multicolor display is determined by the pump microprocessor according to status conditions and keypad entries.

The **microprocessors and other circuitry** which control the pump are located on the printed circuit board. The board contains 3 microprocessors and their associated circuitry, motor driver circuitry, and other miscellaneous circuitry. The LCD module contains the liquid crystal display with its associated circuitry, and the backlight module. The keypad is connected to the microprocessor board via a flex circuit tail. Flexible circuitry and discrete wires connect the pumping mechanism, motor, and sensors to the printed circuit boards.

The **pumping mechanism subassembly** contains the motor, gear train, camshaft, valves, expulsor, sensing disk, occlusion sensor, air detector sensor, cassette sensors, and lock and latch sensors. The pump microprocessor controls motor rotation.

Three **external ports** are used for communication and external power input:

1. The remote dose cord jack is for attachment of the remote dose cord. Patients may use the remote dose cord to begin a PCA dose.
2. The AC power jack is for AC power connection, and can receive input from the AC adapter.
3. The USB port communicates with the CADD[™]-Solis Medication Safety Software via a standard mini-B USB cable attached to a PC computer.

Pumping Operation

Battery Backed RAM

The delivery and recordkeeping parameters for the pump are stored in a battery-backed random access memory (RAM). Battery backup is provided by a lithium manganese dioxide rechargeable battery. This battery is designed to provide a minimum of 10 months of backup power to the memory when the pump is turned off. It takes a maximum of 250 hours with the pump turned on to fully charge a completely discharged backup battery.

Note: The backup battery charges during normal operational use and does not require 250 hours of charging before use.

The internal rechargeable battery is designed to last for 10 years and provide a minimum of 10 full charge and discharge cycles. The shallower the battery discharge, the longer the battery will last.

LCD Circuitry

The LCD circuit contains a power supply that provides bias voltage to the LCD panel. To conserve battery power, the microprocessor disables the LCD drive circuitry when not in use.

An LED backlight is necessary to enable LCD viewing. When the microprocessor enables the LCD, it also enables the LED backlight. A low brightness setting can be used to conserve battery power. Raising the brightness setting of the display makes the display more vibrant at the cost of decreasing pump battery life.

The backlight is shut off by the microprocessor when the LCD is turned off.

The LCD backlight flashes for 12 ms during each motor operation.

LED Status Indicators

An amber and a green light emitting diode (LED) on the front panel of the pump provide pump status to the user. Under software control, the LEDs can either flash at a low duty cycle or be on continuously. A flashing indicator typically indicates a normal mode of operation and a steady “on” indicator typically indicates a fault condition.

Audible Alarm Circuitry

The audible alarm circuitry is backed up by a capacitor. The capacitor provides energy for the alarm if all power is lost while the pump is in the RUN mode. There is enough energy in the capacitor to drive the audible alarm for 2 minutes after the pump has been powered up for 4 minutes or longer.

Power Circuitry

Power for the pump is normally supplied by 4 AA alkaline batteries, the rechargeable battery pack, or the AC adapter. Alkaline AA batteries have a fairly low internal resistance over their discharge range, which keeps power supply noise low. Other types of batteries, such as carbon-zinc, exhibit high internal resistance, especially near depletion. A voltage drop across the internal resistance occurs when current is drawn by the motor during pump activations. This current is demanded in short pulses when the motor is first turned on, and generates large spikes in the battery voltage. This noise can cause the low battery detection circuit to shut down the pump.

Battery Status

Battery State	CADD®-Solis VIP Pump Status
25% to 100%	No alarm
Low battery	<ul style="list-style-type: none"> • Transition to low battery condition • Battery low message appears • Pump emits 3 beeps every 5 minutes • Low battery warning message appears on pump display • Pump is operable • LCD backlight flashes for 12 ms during each motor operation
Depleted battery	<ul style="list-style-type: none"> • Transition to depleted battery condition • Battery depleted message appears • Pump emits a continuous, variable-tone alarm • Depleted battery warning message appears on pump display • Battery power is too low to operate pump • Pump delivery operation stops
Shut down	Pump shuts off due to too low operating voltage.

Pumping Mechanism

The pumping mechanism is linear peristaltic with 2 active valves. Pumping occurs when the expulsor presses on the reservoir tubing in sequence with the inlet and outlet valves. At rest, the outlet valve is pressing down fully on the tubing, and the expulsor and inlet valve are retracted.

A simulated pumping mechanism in a CADD®-Solis VIP pump:

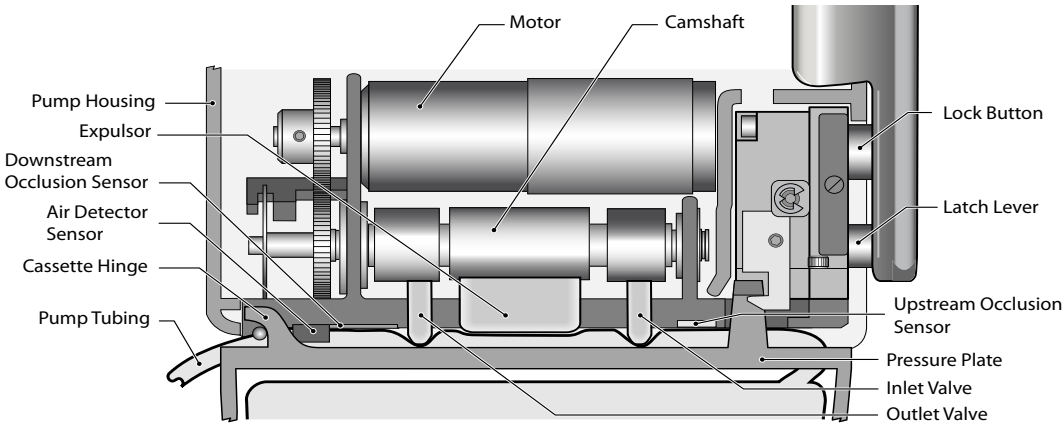

Bottom view:

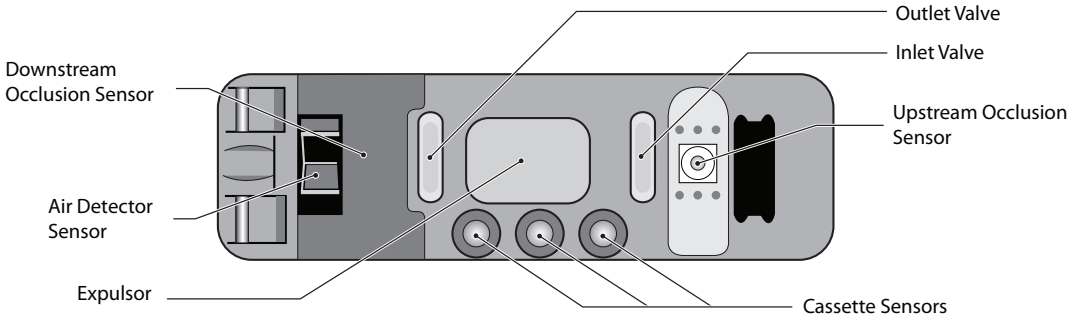

When the microprocessor commands the mechanism to pump, the camshaft begins to rotate, thus controlling the following pump cycle:

1. The inlet valve closes.
2. In synchrony with the expulsor moving down to compress the tubing, the outlet valve opens, expelling fluid.
3. The outlet valve closes.
4. The inlet valve opens as the expulsor is retracted, causing fluid from the reservoir to again fill the pump tubing segment.
5. The camshaft rotation stops after ½ revolution, and the cycle is completed.

Pumping Characteristics

If the fluid path to the patient becomes blocked, the pump tubing expands as pumping occurs. When the amount of inflation corresponds to 18 ± 9 psi (1.24 ± 0.62 bar), the downstream occlusion analog sensor trips, causing the microprocessor to stop the pump mechanism and issue visual and audible alarms. Thus the maximum pressure is 27 psi (1.86 bar).

To deliver the amount of drug specified by the parameter settings, the pump microprocessor causes the pump mechanism to deliver 0.05 mL fluid pulses timed according to the desired rate. At rates higher than 15 mL/hr, 2 pulses in succession are given. Thus, to deliver 20 mL/hr, for example, the microprocessor solves the following equations:

Mechanism activations per hour =

$$\frac{20 \text{ mL/hr}}{0.1 \text{ mL/activation}} = \frac{20}{0.1} = 200 \text{ activations/hr}$$

Time (seconds) between activations =

$$\frac{3600 \text{ s/hr}}{\text{activations/hr}} = \frac{3600}{200} = 18 \text{ seconds between activations}$$

	Rate (mL/hr)	Volume Resolution (mL)
Cassette or Admin Set	0 – 15	0.050
	15.1 – 500	0.100

The microprocessor uses the timer circuits to accurately time the 18 seconds (in this example) between mechanism activations.

Cassette “Type” Sensor Circuit

The cassette “Type” sensor system consists of 3 pins protruding from the bottom of the pump mechanism that interface with the attached CADD® administration set and associated circuitry. Each type of administration set designed to work with the CADD®-Solis VIP pump contains a unique code programmed into the set via features molded into the plastic. When a set is latched to the pump, the features press against the pins in the pump mechanism in a pattern unique to that set type.

Latch/Lock Sensor Circuit

Latch and Lock sensors allow the microprocessor to detect the positions of the latch lever and lock button. This prevents attempted fluid delivery when the set is not correctly latched to the pump. In addition, it allows the microprocessor to stop fluid delivery and enable audible and visual alarms if the set is unlatched during fluid delivery.

Hardware and Software Fault Detection

System Fault Alarm

The CADD[®]-Solis VIP pump performs self-tests on the hardware and software systems. If a system fault code is displayed, one of the self-tests has failed and there may be something wrong with the pump.

If this screen appears, an unrecoverable error may have occurred, such as a hardware or software fault. The amber indicator light is continuously illuminated during these conditions and is accompanied by an audible two-tone alarm. If a system fault occurs, the fault should be reported to Customer Service at Smiths Medical or Smiths Medical International Ltd.

To clear this alarm, you must remove power from the pump by opening the battery door and, if necessary, removing the AC power. Close the battery door and turn the pump back on. If the error code does not repeat, Smiths Medical Customer Service may suggest continued use of the pump. If the error is persistent, the pump must be returned for service.

CAUTION: If the power up results in an error message indicating that the protocol library was lost, do not proceed with using the pump. Follow your facility’s procedures for downloading protocol libraries.

Note: Document the error numbers displayed on the system fault screen to help Smiths Medical Customer Service identify the problem.

Order of System Fault Alarm Events

1. There is a continuous two-tone audible alarm, the amber LED indicator light is on continuously, and the display looks like this:

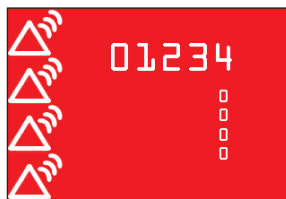

System fault alarm (red).

The numbers relate to the error that caused the system fault.

Record the 5-digit system fault error code for purposes of reporting to Customer Service.

2. To silence/clear the system fault alarm, open the battery door to remove power. If necessary, remove the AC power.
3. Once the system fault alarm has been silenced/cleared, a record of the system fault error code still exists. It can be referenced from 2 places within the pump screens. From the device information report screen, the 5-digit system fault code can be found under the heading, “Last Error Code.” It can also be found on the Event Log report screen under an entry with the heading, “System Fault.” The entry in the event log report remains in memory, and appears on the event log record until 5,000 new log entries have occurred.

Note: Review your facility’s procedure for handling error codes.

Cleaning Procedures

Cleaning Solutions

The following solutions may be used to clean the pump and accessories, unless otherwise specified:

- Soap solution
- Benzalkonium chloride concentrate (0.13%)
- Glutaral concentrate, USP (2%)
- 10% solution of household bleach (1 part household bleach to 9 parts water)
- Alcohol, USP (93%)
- Isopropyl alcohol, USP (99%)
- Chlorhexidine gluconate (4%)
- PDI Super Sani-Cloth[®]
- Madacide (MADA Medical)
- Virex II (Johnson Wax)
- Coverage Spray and Coverage HB Plus (Steris)
- CaviCide[®] (Metrex)
- Quik Fill Compac (A-456-N) (Airkem)

Cleaning the Pump and Accessories

WARNING: Ensure that debris is not allowed to build up on the pressure plate surface of the pumping mechanism. Inspect the air detector sensor slot and remove any debris. A blocked air detector sensor may not detect air present in the fluid path, which could result in serious patient injury or death.

CAUTION:

- Do not immerse the pump in cleaning fluid or water. Do not allow solution to soak into the pump, accumulate on the keypad, or enter the battery compartment, USB port, remote dose cord jack, or power jack areas. Moisture buildup inside the pump may damage the pump.
 - Do not clean the pump with acetone, other plastic solvents, or abrasive cleaners, as damage to the pump may occur.
-

Note: Refer to the instructions for use for each accessory before proceeding with cleaning.

1. Dampen a soft, lint-free cloth with cleaning solution. Apply the solution to the exterior surface of the pump or accessory according to manufacturer's instructions. ***Do not allow the solution to soak into the pump or accessory.***
2. Allow the pump to dry completely before use.

Annual Inspection and Testing Procedures

Inspection Recommendation

Smiths Medical recommends that the following inspection and test procedures be performed annually to verify function and accuracy of the CADD[®]-Solis VIP pump.

Note:

- Become familiar with the CADD[®]-Solis VIP pump before performing the following tests and procedures. Read the Operator's Manual supplied with the pump before proceeding.
- Run the test procedures in manual mode.
- Many of the tests include steps to unlock the keypad. This is necessary only if the keypad is not already unlocked.

CAUTION: CADD[®] pumps are sealed units. A broken or damaged seal will therefore be considered conclusive evidence that the pump has been misused and/or altered, which voids any and all warranties. All service and repair of CADD[®] pumps must be performed by Smiths Medical or its authorized agents.

I. Visual Inspection

- Visually inspect the pump for any damage to the LCD, occlusion sensor seals, valves and expulsor, cassette hinge area, latch handle, USB connector, lock, 3 cassette sensors, keypad, indicator lights, AC power jack, remote dose jack, air detector sensor, and housings.
- Check the battery door for proper operation. It should not be cracked or broken. Inspect the battery door seal for proper position.
- Examine the battery compartment for damage or debris.

II. Mechanical Inspection

Equipment needed

- 1 CADD[™] medication cassette reservoir *or*
1 CADD[®] administration set
- 1 CADD[®] key

Procedure

- Press each key on the keypad. Each key should have a distinctive tactile feel, and should not feel flat.
- Close and latch the battery door. It should fit snugly in place when closed on the pump.
- Attach a CADD[™] medication cassette reservoir or a CADD[®] administration set to the pump. Check for smooth operation of the latch. Gently twist and pull on the cassette to make sure it is firmly attached to the pump.
- Lock the cassette by inserting a key into the lock and turning clockwise into the locked position.

III. Functional Testing

□ Power Up Check / LCD Check

Equipment needed

4 AA batteries

Procedure

1. Insert 4 AA batteries into the pump.
2. Press and hold the power on/off switch.
3. Observe the LCD during power up. The display should quickly flash gray, then blue. An amber swirl should then fill the display, followed by a CADD[®]-Solis Ambulatory Infusion System screen. Look for any stripes, or black or white pixels, which indicate a faulty display.
4. If no error message is immediately shown, and 6 audible beeps occur, the pump powered up normally. If the system fault screen appears prior to the pump displaying the home screen, the pump experienced an electrical or mechanical fault (see System Fault Alarm on page 25).

□ Latch and Lock Check

Equipment needed

- 1 CADD[™] medication cassette reservoir
- 1 CADD[®] key

Procedure

1. Attach and latch a CADD[™] medication cassette reservoir to the pump. The status bar should temporarily show “Reservoir Cassette Latched.”
2. Lock the cassette by inserting a key into the lock and turning clockwise. The status bar should temporarily show “Cassette Locked.”
3. Unlock the cassette by inserting a key into the lock and turning counterclockwise. The status bar should temporarily show “Cassette Unlocked.”
4. Unlatch the cassette. The status bar should temporarily show “Cassette Unlatched and Removed.”

□ Cassette Sensor Test

Equipment needed

- 1 CADD[®] administration set
- 1 CADD[®] key

Procedure

1. Attach and latch a CADD[®] administration set to the pump. The status bar should temporarily show “Standard Admin Set Latched.”
2. Lock the CADD[®] administration set by inserting a key into the lock and turning clockwise. The status bar should temporarily show “Cassette Locked.”
3. Unlock the CADD[®] administration set by inserting a key into the lock and turning counterclockwise. The status bar should temporarily show “Cassette Unlocked.”
4. Unlatch the set. The status bar should show “Cassette Unlatched and Removed.”

□ Motor and “Reservoir Volume is Zero” Alarm Checks

Note: Conduct the Motor and “Reservoir Volume is Zero” Alarm check, and Stopping/Starting the Pump and LED Indicator tests in sequence, as shown below.

Equipment needed

- 1 primed CADD™ medication cassette reservoir containing fluid, and 1 primed CADD® extension set with anti-siphon valve, *or*
1 primed CADD® administration set with anti-siphon valve, *or*
1 CADD® administration set with Flow Stop feature.
- 1 CADD® key
- Timer
- CADD®-Solis remote dose cord

Procedure

1. Program the pump as follows.
 - a. From the home screen, select **Tasks**.
 - b. Under the **View Advanced Tasks** menu, select **Start New Patient**.
 - c. For therapy, select **PCA**.
 - d. For qualifier, select **[Program Manually]**.
 - e. For units, select **mL**.
 - f. Confirm the settings are correct, and select **Yes**.
 - g. The screen displays the “Review pump settings” screen. Select **Review**.
 - h. Program the following parameters.

Continuous Rate	PCA Dose	Reservoir Volume
30.0 mL/hr	0.0 mL	1.0 mL

- i. Once each parameter is correct, select **Accept Value** for that setting.
 - j. When the review is complete, select **Next**.
 - k. The screen displays “Cassette not attached. Attach cassette before starting pump.” Select **Home**.
2. Attach a CADD™ medication cassette reservoir or CADD® administration set to the pump. Latch and lock the cassette.
3. The screen displays “Prime tubing?”. Prime the pump as follows.
 - a. Select **Yes**.
 - b. Unlock the keypad if required, and select **Prime**.
 - c. The screen displays “Reservoir Volume low. Are you sure you want to continue priming?”. Select **Yes**.
4. The pump should begin to prime. Listen to the motor for excessive noise or grinding sounds.
5. The pump should deliver 1.0 mL, and then the display should show “Reservoir Volume is zero. Pump stopped.” Select **Acknowledge**.
6. The reservoir volume in the upper left corner of the display should show 0 mL. If the display shows a different value, verify the pump settings and rerun this test.
7. The screen displays “Reset reservoir volume to 1 mL? Reservoir volume is low.” Select **No**.
8. The screen then displays “Start pump?”. Select **No**.

□ Stopping and Starting the Pump / LED Indicator Test

9. Press stop/start .
10. The display should show “Reset reservoir volume to 1 mL? Reservoir volume is low.” Select **Yes**.
11. The display should show “Start pump?”. Select **Yes**.

12. “Infusion is starting now...” should appear on the screen.
13. The main screen should appear with “Running” in the status bar, and the *green* LED indicator light should blink every 3 seconds.
Note: When the display is blank, the green, amber, or both LED indicators periodically flash to indicate power and running status.
14. An alarm should sound, and “Reservoir volume low.” should appear on the display. Select **Acknowledge**.
15. To stop the pump, press stop/start . When the message “Stop pump?” appears, select **Yes**.
16. The message “Pump is stopping...” appears, and the *amber* LED indicator light blinks. “Stopped” should appear in the status bar.

□ Activation Timing Check

17. Press stop/start . The screen displays “Reset reservoir volume to 1 mL? Reservoir volume is low.” Select **Yes**.
18. The screen displays “Review pump settings.” Select **Review**.
19. Confirm the settings match the parameters in the table in step 1.h. For each parameter select **Accept Value** and then select **Next**.
20. The screen displays “Start pump?”. Select **Yes**.
21. The display should show “Reservoir volume low.” Select **Acknowledge**.
22. Start a timer at the first motor activation, and count the activations. One activation should occur every 12 seconds. After approximately 1 minute, 50 seconds (1:50) and 10 activations, the reservoir empty alarm should occur.
23. The display should show “Reservoir volume is zero. Pump stopped.” Select **Acknowledge**.



□ Remote Dose Cord Check

24. Attach the remote dose cord.
25. From the Tasks menu, select **View Delivery Settings**. Program the pump with the following parameters:

Continuous Rate	PCA Dose	PCA Lockout	Reservoir Volume
0.0 mL/hr	1.0 mL	1 min	10.0 mL

26. From the Tasks menu, select **View Reports**.
27. Highlight and select the “Given and PCA Dose Counters” report.
28. Highlight “Total Given” and select **Clear Given**.
29. Highlight “PCA Doses Given,” and select **Clear Doses**.
30. Press stop/start .
31. The screen displays “Review pump settings.” Select **Review**.
32. Select **Accept Value** for all the parameters, then select **Next**. The screen displays “Start pump?”. Select **Yes**.
33. After “Running” appears on the status bar, press the remote dose cord button and note the time. The pump should beep and begin to deliver.
34. Count the number of pump activations. The pump should make 10 double activations. After 10 double activations, the display should show a reservoir volume of 9.0 mL.
35. Press the remote dose cord button 2 more times within the next 1 minute. The pump should not deliver, and the message “PCA dose not available. Currently locked out.” should display.

□ Doses Given and Doses Attempted Check

36. Stop the pump by pressing stop/start , then select **Yes**.
37. From the View Reports menu, select **Given and PCA Dose Counters**.
38. The display should show “Total Given 1 mL” and “PCA Doses Given 1, PCA Doses Attempted 3.” If the steps in the Remote Dose Cord Check have not been followed exactly, different values may appear.
39. Select **Clear Given**. The display should show “Total Given 0 mL”.
40. Press  to select **PCA Doses Given**.
41. Press **Clear Doses**. The display should show “PCA Doses Given 0, PCA Doses Attempted 0”.

□ Air Detector Test

Equipment needed

- 1 CADD™ medication cassette reservoir **or** 1 CADD® administration set
- 1 primed CADD™ medication cassette reservoir containing fluid and 1 primed CADD® extension set with anti-siphon valve, **or**
1 primed CADD® administration set with anti-siphon valve
- 1 CADD® key

Procedure

1. From the Tasks menu, select **View Advanced Tasks**, and then select **Air and Occlusion Settings**. *Turn the air detector on.*
2. From the Tasks menu, select **View Delivery Settings**. Program the pump with the following parameters:

Continuous Rate	PCA Dose	PCA Lockout	Reservoir Volume
0.0 mL/hr	1.0 mL	1 min	10.0 mL

3. Attach, latch, and lock an *empty* CADD™ medication cassette reservoir or CADD® administration set to the pump.
4. When the screen displays “Reset reservoir volume to 10 mL?”, select **Yes**.
5. When the screen displays “Prime tubing?”, select **No**.
6. When the screen displays “Start pump?”, select **Yes**.
7. The pump should sound a high priority alarm and the display should read “Cannot start pump with air-in line. Prime tubing.” Select **Acknowledge**.
8. Remove the CADD™ medication cassette reservoir or CADD® administration set.
9. Attach, latch, and lock a CADD™ medication cassette reservoir containing fluid and a primed CADD® extension set with anti-siphon valve, or a primed CADD® administration set with anti-siphon valve to the pump. Make certain there is no air in the fluid path.
10. When the screen displays “Prime tubing?”, select **No**.
11. When the screen displays “Start pump?”, select **Yes**.
12. Deliver a PCA dose. The pump should deliver the dose without an air detection alarm.
NOTE: 1 minute must have elapsed since the delivery of the last PCA dose.

□ Battery Fallout Alarm Test

Equipment needed



- 1 CADD™ medication cassette reservoir *or*
1 CADD® administration set
- 1 CADD® key
- Timer

Procedure

1. Program the continuous rate to 1.0 mL/hr.
2. From the Tasks menu, select **View Advanced Tasks**, and then select **Air and Occlusion Settings**. *Turn the air detector off.*
3. Disconnect the AC adapter.
4. Attach, latch, and lock an empty CADD™ medication cassette reservoir or CADD® administration set to the pump.
5. Start the pump and allow it to run for a minimum of 4 minutes.
6. Start a timer to measure the time the audible alarm is active. Open the battery door.
7. The pump should respond with a continuous 2-tone alarm. The alarm should sound for a minimum of 2 minutes.

□ Audible Alarm Check

Procedure

1. From the Tasks menu, select **Display and Sound Settings**, and then select **Alarm Volume**.
2. Scroll and pause on the 3 alarm volumes (low, medium, and high). The pump should sound the alarm as you pause on each volume.
3. Press  or  to verify all 3 audible alarm volumes.

IV. Occlusion Pressure Range Tests

Downstream occlusion and upstream occlusion use stored constants for offset and gain to maintain occlusion accuracy.

Note: Perform either downstream test 1 or test 2, but not both.

□ Downstream Occlusion Pressure Range Test 1

Description:

Pressure is generated by activating the pump mechanism with an attached, filled, clamped CADD™ medication cassette reservoir. The pump is started and a PCA dose is given until the high pressure alarm sounds.

Equipment needed:

- CADD™ medication cassette reservoir containing distilled water.
- 1 CADD® key

Procedure:

1. Turn the pump on and attach a CADD™ medication cassette reservoir containing distilled water. Latch and lock the cassette.
2. Prime the tubing until it is filled with fluid to the end of the Luer lock connector. The system **must** be free from air bubbles for this test.
3. Close the clamp on the distal end of the tubing near the female Luer of the CADD™ medication cassette reservoir.
4. Program the pump to the following parameters:

Units	Continuous Rate	PCA Dose	PCA Lockout	Reservoir Volume
mL	0.0 mL/hr	1.0 mL	1 min	10.0 mL

5. Start the pump and activate a PCA dose, noting when the high pressure alarm is activated.
6. The pump should alarm when the pump delivers between 1 and 2 activations.

□ Downstream Occlusion Pressure Range Test 2

CAUTION: At the completion of the Downstream Occlusion Pressure Range Test 2, the pressure must be reduced to zero before detaching the cassette from the pump; otherwise, the cassette may rupture. Safety glasses should be worn while conducting or observing this test.

Description:

An adjustable metered pressure source is connected to the CADD™ medication cassette reservoir tubing. The pressure is slowly increased until the high pressure alarm sounds

Equipment needed:

- Pressure gauge, 30 psi ± 1 psi (2.07 bar ± 0.07 bar)
- Pressure vessel partially filled with water
- Pressure regulator, 30 psi (2.07 bar)
- CADD™ medication cassette reservoir containing water
- 1 CADD® key
- Safety glasses

Note: Do not use a CADD® extension set with anti-siphon valve.

Procedure:

1. Turn on the pump.
2. Attach, latch, and lock a CADD™ medication cassette reservoir to the pump.
Note: The pressure from the source must be zero when the cassette is attached.

- Assemble the apparatus as shown.

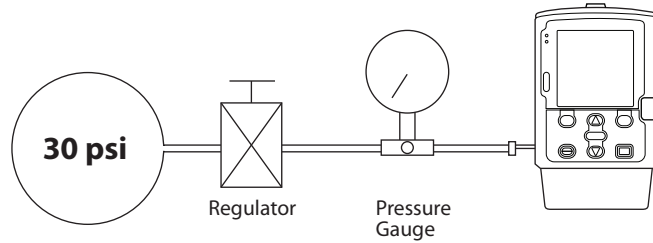

- Connect the CADD™ medication cassette reservoir outlet tube to the metered pressure source.
- Program the pump to deliver a continuous rate of 30 mL/hr.
- Start the pump.
- Slowly increase the back pressure, noting when the high pressure alarm is activated.
Note: The pressure may be increased rapidly to 8 psi (0.55 bar), after which the pressure should be increased at 3 psi/min (0.21 bar/min) or less until the alarm sounds.
- The high pressure alarm should sound between 9 psi and 27 psi (18 psi \pm 9 psi) [between 0.62 bar and 1.86 bar (1.24 bar \pm 0.62 bar)].

CAUTION: At the completion of the Downstream Occlusion Pressure Range Test 2, the pressure must be reduced to zero before detaching the cassette from the pump; otherwise, the cassette may rupture. Safety glasses should be worn while conducting or observing this test.

□ Upstream Occlusion Sensor Test

Description:

The tubing between the fluid reservoir and the pump is occluded while the pump is running until the occlusion alarm sounds.

Equipment needed:

- CADD® administration set with anti-siphon valve
- Tubing clamp (slide clamp or hemostat)

Procedure:

Note: Make sure the upstream occlusion sensor is turned on in the Air and Occlusion Settings under the View Advanced Tasks menu.

- Spike an appropriate standard IV bag.
- Prime the entire fluid path.
- Program the pump to deliver a continuous rate of 30 mL/hr.
- Start the pump.
- Clamp the tubing halfway between the fluid reservoir and the pump.
- The pump should alarm within 3 activations after clamping the tubing.

V. Accuracy Tests

Calibration is not required in order to maintain delivery accuracy. The pump does not require the use of stored calibration values in order to achieve or maintain delivery accuracy.

Note: Perform either the gravimetric test or the volumetric test, but not both.

□ Gravimetric Accuracy Testing

Description:

A CADD™ medication cassette reservoir is partially filled with water and weighed. The cassette is then attached to the pump, and the pump is set to deliver a certain amount of water. The cassette is then removed and weighed again. The amount of water delivered is compared to the amount that the pump should have delivered.

Nominal system accuracy is given in the technical specifications section for the pump. The nominal test conditions are: degassed water at $25 \pm 5^\circ\text{C}$ without back pressure.

Equipment needed:

- CADD™ medication cassette reservoir with attached CADD® extension set **or** CADD™ medication cassette reservoir with Flow Stop feature with attached CADD® extension set
- 50 or 60 mL syringe
- A balance accurate to 0.1 g
- 40 mL room temperature water

Procedure:

1. Fill the syringe with 40 mL water.
2. Transfer the water into a CADD™ medication cassette reservoir. Remove any air from the CADD™ medication cassette reservoir by aspirating the air with the syringe.
3. Fill the syringe with 3–5 mL water.
4. Attach the syringe to the end of the CADD® extension set that does **not** contain the anti-siphon valve. Prime the tubing so it is filled with fluid to the end of the CADD® extension set.
5. Secure the clamp as close as possible to the distal end (anti-siphon valve end) of the CADD® extension set. This should assure a minimum water loss from the tubing when the syringe is removed.
6. Remove the CADD® extension set from the syringe and attach it to the CADD™ medication cassette reservoir.
7. Weigh the entire CADD™ medication cassette reservoir/CADD® extension set assembly and record the weight. This is the **predelivery weight**, and includes the filled CADD™ medication cassette reservoir, and CADD® extension set.
8. Attach the CADD™ medication cassette reservoir to the pump.
9. Program the reservoir volume to 20 mL. This value is the **intended delivery volume**. (1 mL water at 20°C weighs 1 g.)
10. Open the clamp.
11. Program a continuous rate of 0 mL/hr and a PCA dose of 20.0 mL.
12. Start the pump and deliver a PCA dose of 20 mL.
13. Again secure the clamp as close as possible to the distal end (anti-siphon valve end) of the CADD® extension set.
14. Remove the CADD™ medication cassette reservoir from the pump and weigh the entire CADD™ medication cassette reservoir/CADD® extension set assembly. This is the **postdelivery weight**.
15. Calculate the difference in weight between the predelivery weight and the postdelivery weight. This is the **weight of the amount delivered**.

16. Find the difference between the actual delivery volume and the intended delivery volume. This is the **inaccuracy volume**.
17. Divide the inaccuracy volume by the intended delivery volume and multiply by 100. This is the accuracy error percentage.
18. If the accuracy error percentage is greater than $\pm 6\%$, repeat the test with a new CADD™ medication cassette reservoir. If the pump fails a second time, call Smiths Medical.

Example

Pre-delivery Weight	61.1 g
Post-delivery Weight	- 41.6 g
Weight of Amount Delivered	= 19.5 g

Actual Delivery Volume	19.5 mL
Intended Delivery Volume	- 20.0 mL
Inaccuracy Volume	= - 0.5 mL

Inaccuracy Volume	- 0.5 mL
Intended Delivery Volume	÷ 20.0 mL
Accuracy Error	= - 0.025

Accuracy Error	- 0.025
	× 100.00
Accuracy Error Percentage	= - 2.5%

□ Volumetric Accuracy Testing

Description:

A predetermined amount of water is delivered into a collection device such as a burette or graduated cylinder. The amount of water delivered is compared to the amount that the pump should have delivered.

Nominal system accuracy is given in the technical specifications section for the pump. The nominal test conditions are: degassed water at $25 \pm 5^\circ\text{C}$ without back pressure.

Equipment needed:

- CADD™ medication cassette reservoir with attached CADD® extension set *or* CADD™ medication cassette reservoir with flow stop feature with attached CADD® extension set
- 50 mL *or* 60 mL syringe
- A fluid collection device such as a burette *or* a Class A, 25 mL graduated cylinder
- 40 mL room temperature water

Procedure:

1. Fill the syringe with 40 mL water.
2. Transfer the water into a CADD™ medication cassette reservoir. Remove any air from the CADD™ medication cassette reservoir by aspirating the air with the syringe.
3. Fill the syringe with 3–5 mL water.
4. Attach the syringe to the end of the CADD® extension set that does *not* contain the anti-siphon valve. Prime the tubing so it is filled with fluid to the end of the CADD® extension set.
5. Secure the clamp on the CADD® extension set.
6. Remove the CADD® extension set from the syringe and attach it to the CADD™ medication cassette reservoir.
7. Attach the end of the CADD® extension set to the fluid collection device.
8. Attach the CADD™ medication cassette reservoir to the pump.
9. Program the reservoir volume to 20 mL. This is the **intended delivery volume**. Open all clamps.
10. Program a continuous rate of 0.0 mL/hr and a PCA dose of 20.0 mL.
11. Start the pump and deliver a PCA dose of 20 mL.
12. When delivery is complete, record the volume of fluid delivered. This is the **actual delivery**.
13. Find the difference between the actual delivery volume and the intended delivery volume. This is the **inaccuracy volume**.
14. Divide the inaccuracy volume by the intended delivery volume and multiply by 100. This is the **accuracy error percentage**.
15. If the accuracy error percentage is greater than $\pm 6\%$, repeat the test with a new CADD™ medication cassette reservoir. If the pump fails a second time, call Smiths Medical.

Example

Actual Delivery Volume	19.5 mL
Intended Delivery Volume	– 20.0 mL
Inaccuracy Volume	= – 0.5 mL

Inaccuracy Volume	– 0.5 mL
Intended Delivery Volume	÷ 20.0 mL
Accuracy Error	= – 0.025

Accuracy Error	– 0.025
	× 100.00
Accuracy Error Percentage	= – 2.5%

Pump Cleaning and Functional Testing Checklist

The following checklist is only a guide to assist in establishing documentation of cleaning and functional testing for the CADD®-Solis VIP pump. The procedures are described in this Technical Manual. If service is required, fill out a copy of this page and return it with the device.

Serial # _____ Reference # _____ Date _____

I. Visual Inspection

- | | | |
|---|---|--|
| <input type="checkbox"/> LCD | <input type="checkbox"/> Lock | <input type="checkbox"/> Remote dose jack |
| <input type="checkbox"/> Occlusion sensor seals | <input type="checkbox"/> Cassette sensors (3) | <input type="checkbox"/> Air detector |
| <input type="checkbox"/> Valves and expulsor | <input type="checkbox"/> Keypad | <input type="checkbox"/> Pump housing |
| <input type="checkbox"/> Cassette hinge area | <input type="checkbox"/> Indicator lights | <input type="checkbox"/> Battery door |
| <input type="checkbox"/> Latch handle | <input type="checkbox"/> AC power jack | <input type="checkbox"/> Battery compartment |
| <input type="checkbox"/> USB connector | | |

II. Mechanical Inspection

- | | |
|---------------------------------------|---|
| <input type="checkbox"/> Keypad | <input type="checkbox"/> Cassette latch |
| <input type="checkbox"/> Battery Door | <input type="checkbox"/> Cassette lock |

III. Functional Testing

- | | | |
|---|--|--|
| <input type="checkbox"/> Power up, LCD | <input type="checkbox"/> Stop/Start pump, LED | <input type="checkbox"/> Air detector |
| <input type="checkbox"/> Latch/Lock | <input type="checkbox"/> Activation timing | <input type="checkbox"/> Battery fallout alarm |
| <input type="checkbox"/> Cassette sensor | <input type="checkbox"/> Remote dose cord | <input type="checkbox"/> Audible alarm |
| <input type="checkbox"/> Motor, reservoir is zero | <input type="checkbox"/> Doses given/attempted | |

IV. Occlusion Pressure Range Tests

Note: Perform either downstream test 1 or test 2, but not both.

Downstream Test 1: Activations before alarm _____

Downstream Test 2: High pressure alarm at _____ psi

Upstream Occlusion Sensor Test: Pass _____ Fail _____

V. Accuracy Tests

Note: Perform either the gravimetric or the volumetric test, but not both.

Gravimetric Accuracy Test

Pre Delivery Weight (g)	Post Delivery Weight (g)	Amount Delivered (mL)	Intended Delivery Volume (mL)	Inaccuracy Volume (mL)	Accuracy Error	Accuracy Error (%)

Volumetric Accuracy Test

Intended Delivery Volume (mL)	Actual Delivery Volume (mL)	Inaccuracy Volume (mL)	Accuracy Error	Accuracy Error (%)

CADD®

Smiths Medical ASD, Inc.

St. Paul, MN 55112 USA
1 800.258.5361 (USA)
1 214.618.0218
www.smiths-medical.com

EC REP

Smiths Medical International Ltd.

TN25 4BF, UK
+44 (0) 1233 722100

AUS REP

Smiths Medical Australasia Pty. Ltd.

61 Brandl Street
Eight Mile Plains, QLD 4113, Australia
+61 (0) 7 3340 1300

CE
0473

CADD-Solis, CADD, and the CADD and Smiths Medical design marks are trademarks of Smiths Medical. The symbol ® indicates the trademark is registered in the U.S. Patent and Trademark Office and certain other countries. All other names and marks mentioned are trade names, trademarks, or service marks of their respective owners.

© 2012 Smiths Medical. All rights reserved.