

## Description of the CADD-Prizm® VIP Pump

The Deltec CADD-Prizm® ambulatory drug delivery pump provides measured drug therapy to patients in hospital or outpatient settings.

The **PCA (Patient-Controlled Analgesia)** delivery mode is used for therapies that require a continuous rate of infusion, patient-controlled demand doses, or both, such as patient-controlled analgesia.

The **Continuous** delivery mode allows the infusion of drug at a constant, programmed rate.

The **TPN (Total Parenteral Nutrition)** delivery mode allows the infusion of nutritional solutions or other fluids, with optional tapering at the beginning and end of infusion.

The **Intermittent** delivery mode allows the infusion of a specific volume of drug at a regular, programmed interval.

### **Epidural/Subarachnoid Administration**

The selected drug must be used in accordance with the indications included in the package insert accompanying the drug. Administration of any drug by this pump is limited by any warnings, precautions, or contraindications in the drug labeling.

**Analgesics** Administration of analgesics to the epidural space is limited to use with indwelling catheters specifically indicated for either short- or long-term drug delivery. Administration of analgesics to the subarachnoid space is limited to use with indwelling catheters specifically indicated for short-term drug delivery.

**Anesthetics** Administration of anesthetics to the epidural space is limited to use with indwelling catheters specifically indicated for short-term drug delivery.

**WARNING: Administration of drugs to the epidural space or subarachnoid space other than those indicated for administration to the epidural space or subarachnoid space could result in death or serious injury to the patient. To prevent the infusion of drugs that are not indicated for epidural space or subarachnoid space infusion, DO NOT use administration sets that incorporate injection sites. The inadvertent use of injection sites for infusion of such drugs may cause death or serious injury to the patient. If the reservoir or cassette is used for epidural space or subarachnoid space drug delivery, it is strongly recommended that it be clearly differentiated from reservoirs, cassettes, or administration sets used for other routes of infusion, for example, by color coding, or other means of identification.**

## Pump Diagram

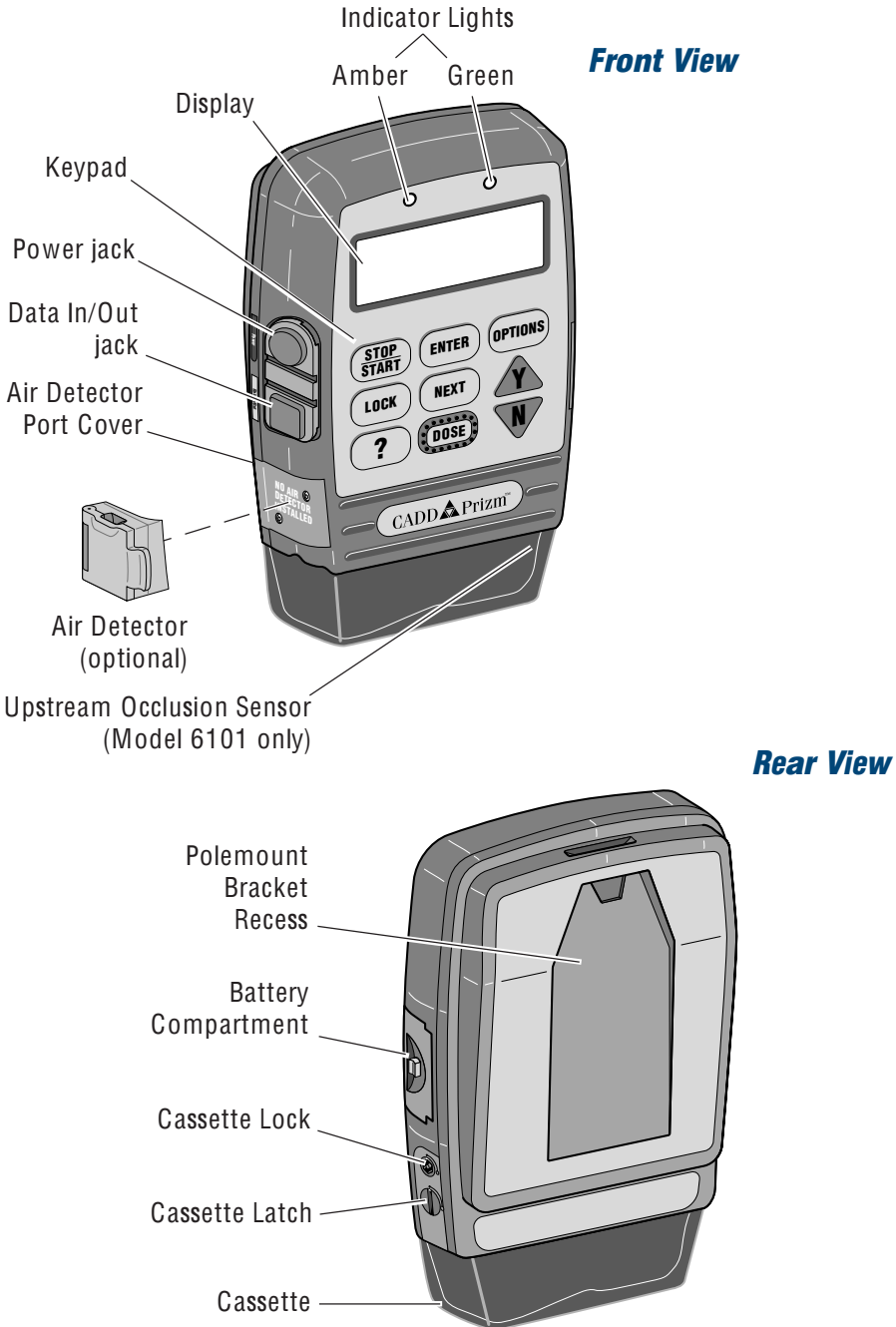

## Callout Descriptions

### ***Indicator Lights***

**Green:** flashes when the pump is running

**Amber:** flashes when the pump is stopped or alerting to an alarm; lit continuously when the pump is inoperable

### ***Display***

Shows programming information and messages

### ***Power jack***

Connects to a CADD External Power Source (EPS) System Power Pack or an AC Adapter for wall outlet

### ***Data In/Out jack***

Used for attaching accessories:

- **Interface Cable** for printing reports
- **Remote Dose Cord** for remote operation of the dose key
- **Modem cable** for communications





### ***Cassette***

The portion of the reservoir or administration set that attaches to the bottom of the pump

### ***Polemount Bracket recess***

Bracket slides into the recess on the back of the pump, for attaching the pump to an IV pole

### ***Keypad***

-  starts and stops pump delivery
-  displays or changes the lock level; allows access to the Clinician Bolus in the PCA delivery mode
-  displays more information for a screen or an alarm message
-  saves a new value when programming; records a selection from a menu; clears recordkeeping screens
-  scrolls through programming screens without changing the settings; returns you from the Biomed Toolbox Menu to the Options Menu, or from the Options Menu to the main screen

***Keypad (continued)***



in the PCA delivery mode, delivers a programmed amount of medication



displays the Options Menu



answers “yes, increases values on programming screens, or scrolls through items on a menu



answers “no,” decreases values on programming screens, scrolls through items on a menu, or cancels printing

## Installing a Battery

Use a fresh, 9 volt alkaline or lithium battery such as the DURACELL® Alkaline MN 1604 or the ULTRALIFE® Lithium U9VL battery. The pump retains all programmed values while the battery is removed. If the pump is running, you may connect an external power source to keep the pump running for 3 minutes while you change the battery.

### CAUTION:

- ⊗ **Do not use rechargeable NiCad batteries. Do not use carbon zinc (“heavy duty”) batteries. They do not provide sufficient power for the pump to operate properly.**
- ⊗ **Do not store the pump for prolonged periods with the battery installed. Battery leakage could damage the pump.**

### WARNING:

- ⊗ **Because there is no pump alarm to alert users that a battery has become dislodged due to a damaged battery compartment cover becoming separated from the pump or improper battery installation, it is important to carefully follow battery installation procedures.**
- ⊗ **If the pump is dropped or hit against a hard surface, the battery door may become broken or damaged. DO NOT USE the pump if it has been damaged in this way because the battery will not be properly secured; this may result in loss of power, nondelivery of drug, and, depending on the type of drug being administered, death or serious injury.**

### To install a battery

1. Make sure the pump is stopped. Press the button on the battery door and slide the battery door forward. Remove the used battery.
2. Match the + and - markings on the new battery with the markings on the pump. Insert the battery. The pump will beep if the battery is inserted correctly.
3. Replace the battery door.

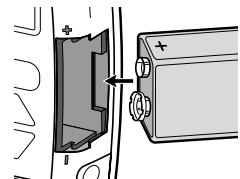
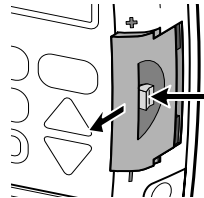

## The Main Screen

The main screen is the starting point for programming or viewing the pump's settings. If no keys are pressed, the display will eventually revert to the main screen. The main screen within each delivery mode displays information about the delivery status, as shown below.

### PCA Delivery Mode

```

*** PCA 6210X ***
Battery Low RUNNING
Res Vol 50.0 ml
Press NEXT to advance
    
```

**Power source status\***

**Delivery mode**

“RUNNING” if the pump is running  
 “DOSING” if a Demand Dose is in progress  
 “STOPPED” if the pump is stopped

### Continuous Delivery Mode

```

*** CONT 6220X ***
Battery Low RUNNING
Res Vol 50.0 ml
Press NEXT to advance
    
```

“RUNNING” if the pump is running  
 “STOPPED” if the pump is stopped

The current Reservoir Volume

Reminder that the NEXT key advances to programming screens

### TPN Delivery Mode

```

*** TPN 6230X ***
Battery Low RUNNING ↑
Res Vol 50.0 ml
Press NEXT to advance
    
```

“RUNNING ↑” if delivery is tapering up  
 “RUNNING ≥” if delivering at the plateau rate  
 “RUNNING ↓” if delivery is tapering down  
 “RUNNING K” if delivering the KVO  
 “RUNNING I” if immediately tapering down  
 “STOPPED” if the pump is stopped

### Intermittent Delivery Mode

```

*** INT 6240X ***
Battery Low DOSING
Res Vol 50.0 ml
Press NEXT to advance
    
```

“DOSING” if a dose is in progress  
 “KVO” if the KVO rate is in progress  
 “KVO=0” if the pump is running but no KVO is programmed  
 “STOPPED” if the pump is stopped  
 “DELAY” if the dose is delayed by Next Dose Start Time (KVO is delivering)



\* The Power Source Status will only display when the 9 volt battery is low, unless the pump has been customized to **always** show the type of power source in use.

## Getting Help Using the Key

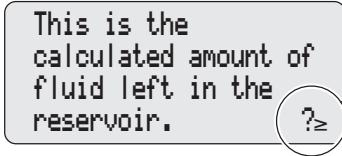
For more information about a screen or message on the pump's display, press the  key to view help screens.



*This symbol in the lower right corner means there are additional help screens. Press the  key again to see the next help screen.*

- To page through all the help screens, press  repeatedly. The original screen will reappear when no further help is available.
- To exit help, press any key (other than the  key). This will bring you back to the original screen.
- If a help screen tells you to press a certain key, first exit help, then press that key.

Help screens are lock level dependent. If the pump's current lock level prevents access to a certain function, the function will not be described in the help screens.

## Lock Level Table

Lock levels are used to limit patient access to certain programming and operating functions.

This table shows the features that can be accessed in each lock level. LL0 permits complete access to all programming and operating features. LL1 permits limited programming and access, and LL2 permits only minimal access.

Pump Operations and Programming	Stopped		
	LL0	LL1	LL2
Stop/Start the pump	Yes	Yes	Yes
View Help screens	Yes	Yes	Yes
Print	Yes	Yes	Yes
Reset Reservoir Volume	Yes	Yes	Yes
Reset Infusion Profile (TPN)	Yes	Yes	Yes
Change the lock level	Yes, w/code	Yes, w/code	Yes, w/code
Change the program	Yes	Within LL0 Limits*	No
Change Next Dose Start Time (INTERMT)	Yes	No	No
Clear Given amount	Yes	Yes	No
Clear Dose Counters (PCA)	Yes	Yes	No
<b>Options</b>			
Immediate Taper-Down (TPN)	Yes, programmable	Yes, programmable	Yes, <i>not</i> programmable
Prime	Yes	Yes	No
Time Remaining, view (INTERMT)	Yes	Yes	Yes
Extended History, view (PCA)	Yes	Yes	Yes
Change Delivery Modes	Yes, w/code	No	No
AutoLock	Yes	View only	View only
Time	Yes	View only	View only
Date	Yes	View only	View only
Air Detector On/Off	Yes	View only	View Only
Event Log, view	Yes	Yes	Yes
Biomed Toolbox	Yes, w/code	No	No

**\* In PCA and CONTIN delivery modes**



## Changing the Lock Level









Before programming the pump, make sure the lock level is LL0 so you can access all programming screens.

**After programming, the lock level must be changed to LL1 or LL2 to prevent the patient from having complete access to all programming and operating functions.**

If AutoLock is not in use and the lock level is LL0 when you attach a cassette, the message “AutoLock not in use / Change Lock Level from LL0?” will appear; this allows you to set the lock level to LL1 or LL2 with the steps below. For detailed information on lock levels, see page 8.

**NOTE:** You may change the lock level at any time by stopping the pump and pressing . Then begin with step 2 below.

### To change the lock level

1. With this message displayed, press . (If you do not wish to change the lock level at this time, press .)
2. The current lock level will appear.
3. Press  or  until the desired lock level (LL1 or LL2) appears.
4. Press  again. “000” will appear.
5. Press  or  until the Lock Level Code appears.
6. Press  to set the new lock level. Watch the display to verify that the correct lock level is being entered.

AutoLock not in use.  
Change Lock Level  
from LL0?  
Press Y or N

Lock Level  
LL0

Lock Level  
LL1

Lock Level Code  
000

Lock Level Code  
XXX





Lock Level  
LL1  
<Changing...>

## Changing Delivery Modes



The CADD-Prizm pump contains four delivery modes: PCA, CONTIN, TPN, INTERMT. (The pump also contains a Communications mode; for more information, refer to page 47 and the product literature accompanying the CADD-Ambassador™ Pump Communications System or the CADD-Diplomat™ PC Communications System.) To change the mode, you must know the Access Code (Lock Level Code plus 10). When you change the mode, the program will revert to the default settings, and the Event Log will clear. Therefore, you may wish to print the Event Log before changing the mode. Other Options settings will not be affected.

### To change the delivery mode

The pump must be stopped and in LL0.



1. Press .  
Press  or  until “**Delivery Modes**” appears, then press .

```
Options
  ⚡ Delivery Modes
Press ▲ or ▼ or ENTER
```



2. Press  or  until the Access Code appears (See the *Operator's Manual*; Lock Code +10).  
Then press .

```
Access Code
  XXX
```

**NOTE:** If the Lock Level Code has been customized, use the **new** Lock Level Code+10.

3. Press  or  to select the desired delivery mode. Then press .

```
Select
  ⚡ CONTIN 6220X
Press ▲ or ▼ or ENTER
```

4. Press  to confirm the change.  
The pump will go through the power up sequence in the new delivery mode. If messages appear, refer to the table on page 56 or press  for help.

```
Change Delivery Mode
to CONTIN 6220X?
Press Y or N
```

5. After the power up sequence, this message will appear followed by the first programming screen in the new delivery mode.

```
Pump is ready to
program
NEXT to continue
```

## Starting the Pump

When you start the pump, programmed values will be automatically reviewed. Then fluid delivery will begin as programmed and the green indicator light will blink. **If the pump will not start**, a message will appear on the display. Refer to the Messages and Alarms Table on page 56.

### To start the pump

1. Press  “Start the Pump?” will appear.

Start the Pump?

Press Y or N

2. Press . “Starting Pump” will appear.

Starting pump...

The pump will review the program, lock level, AutoLock setting, Air Detector status, time, and date.

If AutoLock is in use, “AutoLock is changing lock level to (LL1 or LL2)” will appear.

AutoLock is  
changing Lock Level  
to LL2

## Stopping the Pump

When the pump is stopped, no delivery occurs. “STOPPED” appears on the main screen and the amber indicator light blinks.

### To stop the pump

1. Press .

If a Demand Dose or Clinician Bolus is in progress, “Stop Demand Dose?” or “Stop Clinician Bolus?” will appear. Press  to stop the dose.

Stop Demand Dose?

Press Y or N

2. When “Stop the Pump?” appears, press .

Stop the Pump?

Press Y or N



## PCA Cycle Graph and Programming Screens

The PCA delivery mode provides the following methods of delivery:

- **Continuous Rate**
- **Demand Dose**, activated by the patient
- **Clinician Bolus**, a loading dose activated by the clinician.

You may program a Continuous Rate, a Demand Dose, or both. The Clinician Bolus is described later in this section.

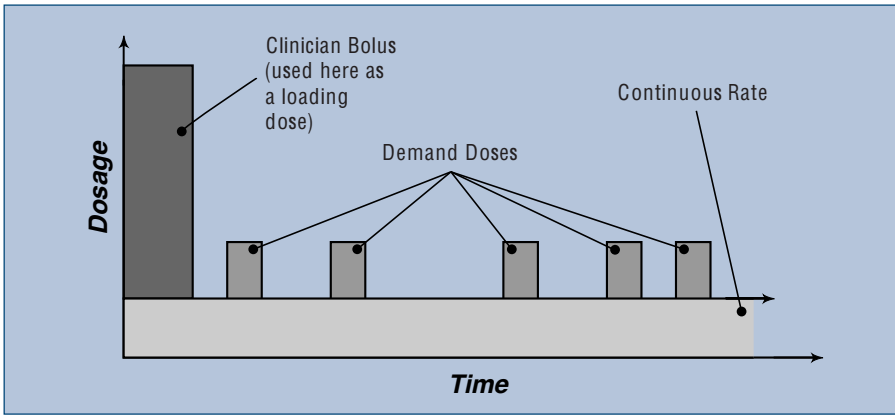

The following figure shows the programming screens in the PCA delivery mode:

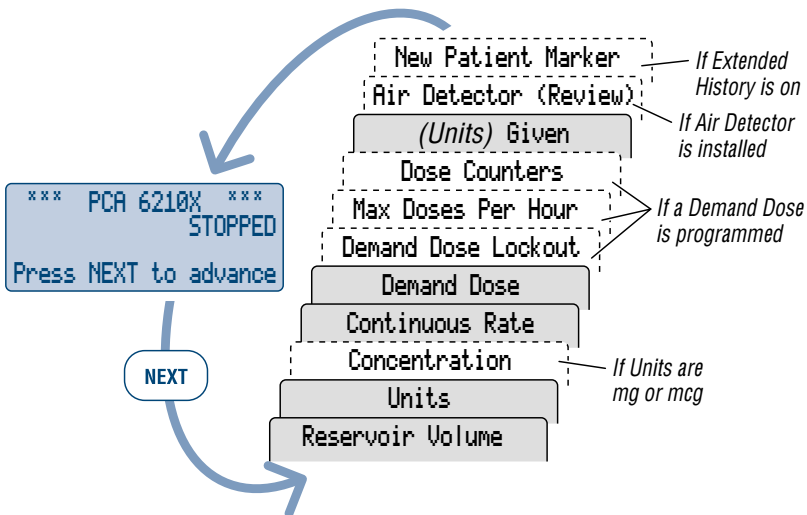



# PCA Programming

## ***Before programming:***

- Stop the pump and change the Lock Level to LL0 as described on page 9.
- Select the PCA delivery mode as described in Changing Delivery Modes on page 10. If the pump is already in the PCA delivery mode, you may select it again to clear all programming screens to their default settings.

### **1. Begin at the main screen**

- Make sure the pump is in LL0.
- Make sure PCA and STOPPED appear on the main screen.
- Press **NEXT** to begin.

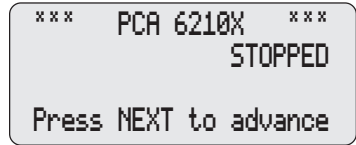

### **2. Enter the Reservoir Volume**

- Press **▲** or **▼** to select the volume of fluid in a filled reservoir. (If you do not wish to use the Reservoir Volume feature, scroll down to “Not In Use” located before 1.)
- Press **ENTER**.

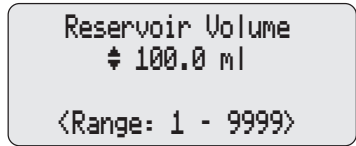

### **3. Enter the Units**

To accept the current programming Units, press **NEXT**.

Or, to change the units:

- Press **▲** or **▼** to select the desired programming units.
- Press **ENTER**.
- Press **▲** to confirm the change.

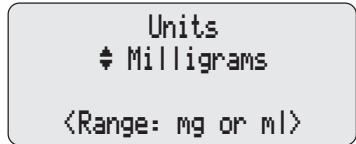

**NOTE:** If the prescription calls for milliliters, enter Milliliters and skip to step 5.

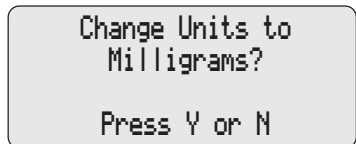



### 4. Enter the Concentration of the drug

This screen will not appear if the units are milliliters; go to step 5.

- Press **▲** or **▼** to select the desired concentration. (If you cannot select the desired concentration, it may have been turned off in the Biomed Toolbox.)

```
Concentration
  † 1.0 mg/ml
<Range: 0.1 - 100>
```

- Press **ENTER**.

```
Change Concentration
to 1.0 mg/ml?
Press Y or N
```

- Press **▲** to confirm the change.

**NOTE:** If you change the Concentration, you must enter the Continuous Rate and Demand Dose.

### 5. Enter the hourly Continuous Rate

- Press **▲** or **▼** to select the desired continuous rate of drug delivery.

```
Continuous Rate
  † 5.00 mg/hr
<Range: 0 - 30.00>
```

- Press **ENTER**.

**NOTE:** If "Change Rate to...?" appears, you must confirm the rate because the Units or Concentration was changed, or the rate is greater than or equal to 100 mg/hr or mcg/hr. Press **▲** to confirm, or press **▼** and re-enter the rate.

### 6. Enter the Demand Dose amount

- Press **▲** or **▼** to select the desired amount delivered when patient presses the DOSE key.

```
Demand Dose
  † 2.50 mg
<Range: 0 - 9.90>
```

- Press **ENTER**.

**NOTE:** If "Change Demand Dose to...?" appears, you must confirm the dose because the Units or Concentration was changed, or the dose is greater than or equal to 100 mg or mcg. Press **▲** to confirm, or press **▼** and re-enter the dose.



## 7. Enter the Demand Dose Lockout time

If Demand Dose is zero, this screen will not appear; go to step 10.

- Press ▲ or ▼ to select the desired lockout time that must elapse between demand doses.
- Press **ENTER**.

```
Demand Dose Lockout
  ⚡      15 Min
<Range: 5 min-24 hr>
```

**CAUTION:** When you enter a new value, any lockout time in effect will be cleared. A Demand Dose could be requested immediately upon starting the pump.

## 8. Enter the Max Doses Per Hour

If Demand Dose is zero or the Lockout is one hour or greater, this screen will not appear; go to step 10.

- Press ▲ or ▼ to select the maximum number of doses allowed per one hour period.
- Press **ENTER**.

```
Max Doses Per Hour
  ⚡      2
<Range: 1 - 4>
```

**NOTE:** The number shown on this screen may be outside of the range; this can happen when the Demand Dose Lockout time is changed but the Max Doses Per Hour number is not adjusted. If you scroll through the numbers, only numbers within the range will appear.

**CAUTION:** When you enter a new value, any lockout time in effect will be cleared. A Demand Dose could be requested immediately upon starting the pump.

## 9. Clear the Dose Counters

If Demand Dose is zero, this screen will not appear; go to step 10.

- Press **ENTER** if you wish to clear the number of demand doses attempted since date and time shown; even if the counters are zero, this updates the time and date markers.

```
Dose Counters
Given/Attempt: 0/ 0
since 06/08/96 10:35
Press ENTER to clear
```

### 10. Clear the units Given

- Press **ENTER** if you wish to clear the total amount delivered since the time and date shown; even if the amount is zero, this updates the time and date markers.

```
Milligrams Given
  0.00 mg
since 06/08/96 10:35
Press ENTER to clear
```

### 11. Verify the Air Detector status

*This screen will appear only if an Air Detector is installed.*

- Make sure the setting is correct.  
**NOTE:** If the Air Detector is not required, this screen will show whether it is turned on or off.
- Press **NEXT** to continue. If you need to correct the Air Detector setting, see the *Operator's Manual*.

```
Air Detector
Required
<Review Only>
```

### 12. Enter a New Patient Marker (optional)

*This screen will appear only if the Extended History is on.*

If you do not wish to add a New Patient Marker, press **NEXT**.

If you wish to add a New Patient Marker to the Event Log,

- Press **ENTER**.
- Press **▲**. This will clear the Extended History from the last patient and add a marker to the Event Log. The main screen will reappear.

```
To insert New Patient
Marker and clear
Extended History
press ENTER
```

```
Clear Extended
History and insert
New Patient Marker?
Press Y or N
```

### 13. Review the program

Press **NEXT** repeatedly to review the programming screens. If you need to reprogram a setting, press **NEXT** until the appropriate screen appears and change the setting as described in this section.





## PCA: Programming with Upper Limits, Adjusting Doses in Lock Level 1

If a prescription allows for the Continuous Rate or Demand Dose to be adjusted during the course of therapy, you may wish to operate the pump in LL1. Then, when necessary, you can adjust the Continuous Rate or the Demand Dose values up to the maximum value that was programmed in LL0.

### **Programming the pump to use this feature**

1. During initial programming in LL0, enter the **upper limit** values for the Continuous Rate and/or Demand Dose. (These will be the maximum values when the pump is in LL1.)

```
Demand Dose
⬆ 5.00 mg
<Range: 0 - 9.90>
```

2. After you are finished programming, change the lock level to LL1.

3. Decrease the Continuous Rate or Demand Dose to its starting value, then press **ENTER**. “Range: Limited” indicates you cannot increase the value beyond the maximum programmed in LL0.

```
Demand Dose
⬆ 2.50 mg
<Range: Limited>
```

### **Adjusting the rate or dose while the pump is in use**



If it becomes necessary to increase the Continuous Rate or Demand Dose during the course of therapy, stop the pump but **remain in LL1**.

1. Press **NEXT** until the Continuous Rate or Demand Dose screen appears.
2. Press **▲** or **▼** to select the desired value, then press **ENTER**. “Range: Limited” indicates you cannot increase the value beyond the maximum.
3. Restart the pump if appropriate.

```
Demand Dose
⬆ 3.00 mg
<Range: Limited>
```







### PCA: Starting a Clinician Bolus



1. Make sure the pump is running (in any lock level). Start the pump if necessary.
2. Press .
3. Press  until the Clinician Bolus Code appears on the display (See *Operator's Manual*).
4. Press  again.

```
Clinician Bolus Code
  XXX
```

**WARNING: To prevent the patient from accessing the Clinician Bolus function, do not let the patient know this code.**

5. Press  or  to select the desired amount.
6. Press  or .

```
Clinician Bolus
  10.00 mg
Range <0 - 20.00>
```

**NOTE:** If you enter a value of 100, a screen will appear asking you to confirm the value. Press  to confirm, or  to re-enter the value.

7. The screen will show the amount decreasing as the bolus is delivered.

```
Clinician Bolus
  10.00 mg
<Delivering...>
```

### PCA: Starting a Demand Dose

If a Demand Dose has been programmed, the patient may start a Demand Dose while the pump is running. If no Demand Dose has been programmed, the pump will display the message “Dose not delivered, No Dose programmed.”

1. Make sure the pump is running (in any lock level). Start the pump if necessary.
2. Press  (or the button on the Remote Dose Cord, if attached). Two beeps will sound and the pump will begin delivering the Demand Dose.

```
Demand Dose
  Started
```

```
NEXT to continue
```

As the Demand Dose is delivered, the main screen will show “DOSING” in place of “RUNNING.”

```
*** PCA 6210X ***
Low Battery   DOSING
Res Vol      47.0 ml
Press NEXT to advance
```



## PCA: Stopping a Demand Dose or Clinician Bolus

A Demand Dose or Clinician Bolus may be stopped in progress.

1. Press .



One beep will sound and the message “Stop Demand Dose?” or “Stop Clinician Bolus?” will appear.

Stop Demand Dose?

Press Y or N

2. Press  to stop the dose and to cancel the remainder of the dose. “Demand Dose Stopped” or “Clinician Bolus Stopped” will appear.

Demand Dose  
Stopped

3. When “Stop the Pump?” appears,
  - press  to remain running, or
  - press  to stop the pump.

Stop the Pump?

Press Y or N



## Continuous Cycle Graph and Programming Screens

The Continuous delivery mode provides a continuous rate of delivery in milliliters per hour.

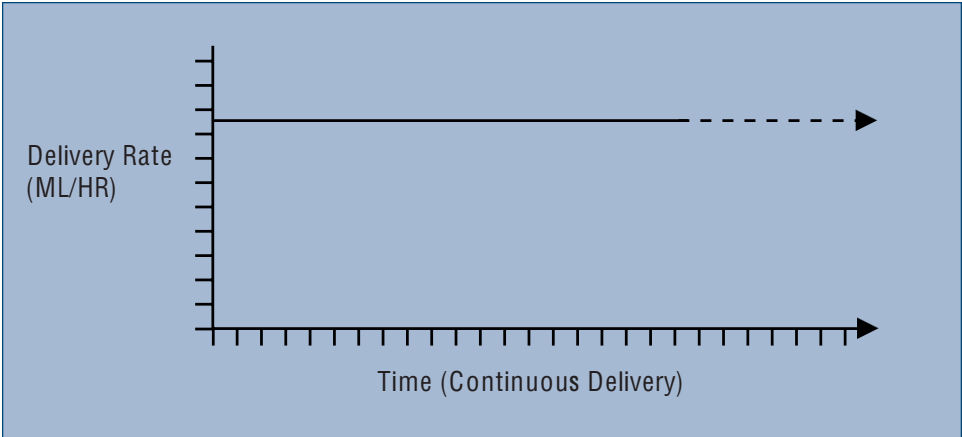

The following figure shows the programming screens in the Continuous delivery mode:

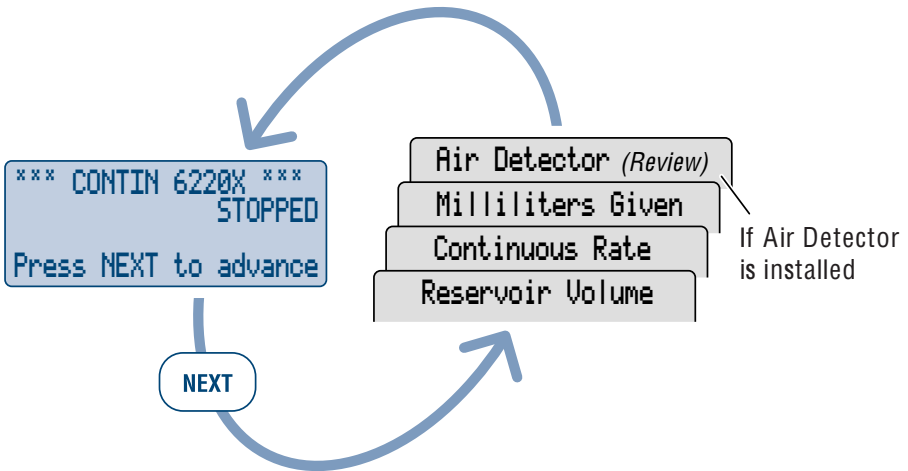



## Continuous Programming

### ***Before programming:***

- Stop the pump and change the Lock Level to LL0 as described on page 8.
- Select the Continuous (CONTIN) delivery mode as described in Changing Delivery Modes on page 10. If the pump is already in the CONTIN delivery mode, you may select it again to clear all programming screens to their default settings.

### **1. Begin at the main screen**

- Make sure the pump is in LL0.
- Make sure CON and STOPPED appear on the main screen.
- Press **ENTER** to begin.

```
*** CON 6220X ***
                STOPPED
Press NEXT to advance
```

### **2. Enter the Reservoir Volume**

- Press **▲** or **▼** to select the volume of fluid in a filled reservoir. (If you do not wish to use the Reservoir Volume feature, scroll down to “Not In Use” located before 1.)
- Press **ENTER**.

```
Reservoir Volume
  ± 100.0 ml
<Range: 1 - 9999>
```

### **3. Enter the hourly Continuous Rate**

- Press **▲** or **▼** to select the desired continuous rate of drug delivery.
- Press **ENTER**.

```
Continuous Rate
  ± 0.5 ml/hr
<Range: 0.1 - 350.0>
```

### **4. Clear the Milliliters Given**

- Press **ENTER** if you wish to clear the milliliters delivered since the time and date shown; even if the amount is zero, this updates the time and date markers.

```
Milliliters Given
  0.0 ml
since 01/08/96 10:35
Press ENTER to clear
```



### 5. Verify the Air Detector status

This screen will appear only if an Air Detector is installed.

- Make sure the setting is correct.

**NOTE:** If the Air Detector is not required, this screen will show whether it is turned on or off.

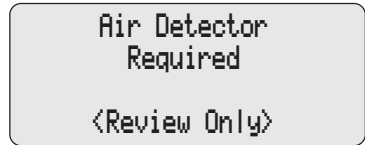

- Press **ENTER** to continue. If you need to correct the Air Detector setting, see the *Operator's Manual*.

### 6. Review the program

Press **NEXT** repeatedly to review the programming screens. If you need to reprogram a setting, press **NEXT** until the appropriate screen appears and change the setting as described in this section.



## CONTIN: Programming with Upper Limits, Adjusting Rate in Lock Level 1

If a prescription allows for the Continuous Rate to be adjusted during the course of therapy, you may wish to operate the pump in LL1. Then, when necessary, you can adjust the Continuous Rate up to the maximum value that was programmed in LL0.

### *Programming the pump to use this feature*

1. During initial programming in LL0, enter the **upper limit** value for the Continuous Rate. (This will be the maximum value when the pump is in LL1.)
2. After you are finished programming, change the lock level to LL1.
3. Decrease the Continuous Rate to its starting value. “Range: Limited” indicates you cannot increase the value beyond the maximum programmed in LL0.

```
Continuous Rate
⚡ 5.0 ml/hr
<Range: 0 - 350.0>
```

```
Continuous Rate
⚡ 2.5 ml/hr
<Range: Limited>
```

### *Adjusting the rate while the pump is in use*

If it becomes necessary to increase the Continuous Rate during the course of therapy, stop the pump but **remain in LL1**.

1. Press **NEXT** until the Continuous Rate screen appears.
2. Press **▲** or **▼** to select the desired value, then press **ENTER**. “Range: Limited” indicates you cannot increase the value beyond the maximum.
3. Restart the pump if appropriate.

```
Continuous Rate
⚡ 5.0 ml/hr
<Range: Limited>
```



## TPN Cycle Graph and Programming Screens

The TPN delivery mode allows the high volume delivery of solutions, with optional tapering. Delivery can be gradually increased or “tapered up” at the beginning of the infusion profile, or it can be gradually decreased, or “tapered down” at the end of the infusion profile. An automatic Keep Vein Open (KVO) rate is delivered at the end of the infusion profile.

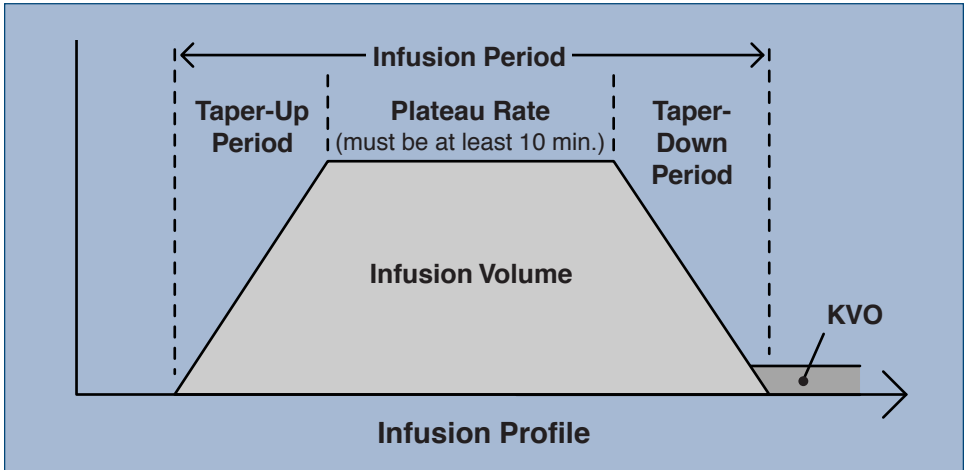

The following figure shows the programming screens in the TPN delivery mode:

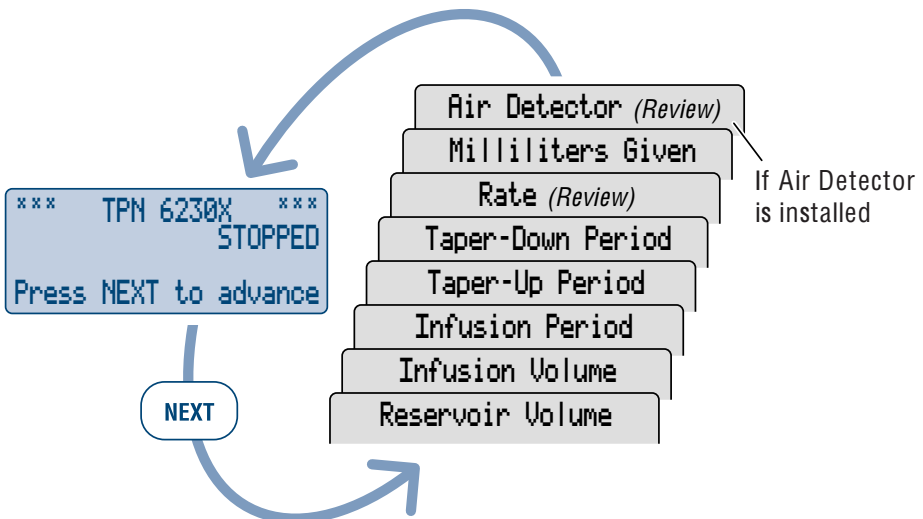



## TPN Programming

### ***Before programming:***

- ☞ Stop the pump and change the Lock Level to LL0 as described on page 9.
- ☞ Select the TPN delivery mode as described in Changing Delivery Modes on page 10. If the pump is already in the TPN delivery mode, you may select it again to clear all programming screens to their default settings.

### **1. Begin at the main screen**

- ☞ Make sure the pump is in LL0.
- ☞ Make sure TPN and STOPPED appear on the main screen.
- ☞ Press **ENTER** to begin.

```
*** TPN 6230X ***
                STOPPED
Press NEXT to advance
```

### **2. Enter the Reservoir Volume**

- ☞ Press **▲** or **▼** to select the volume of fluid in a filled reservoir. (If you do not wish to use the Reservoir Volume feature, scroll down to “Not In Use” located before 10.0.)
- ☞ Press **ENTER**.

```
Reservoir Volume
  ⚡ 1000 ml
<Range: 10.0 - 9990>
```

### **3. Enter the Infusion Volume**

*When this screen is first displayed, the third line may show the volume left from the last infusion period. As soon as you begin scrolling to a new Infusion Volume, it will disappear.*

- ☞ Press **▲** or **▼** to select the desired volume of fluid to be delivered in milliliters.
- ☞ Press **ENTER**.

```
Infusion Volume
  ⚡ 1000.0 ml total
<Range: 10 - 9990>
```

#### 4. Enter the Infusion Period

When this screen is first displayed, the third line may show the amount of time left from the last infusion period. As soon as you begin scrolling to a new Infusion Period, it will disappear.

- Press **▲** or **▼** to select the period over which infusion volume will be delivered.
- Press **ENTER**.

```

Infusion Period
  10 hrs 00 min
<Range: 3:00-99:50>
    
```

#### 5. Enter the Taper-Up Period

- Press **▲** or **▼** to select the period over which infusion will gradually increase to plateau rate.
- Press **ENTER**.

```

Taper-Up Period
  1 hrs 30 min
<Range: 0:00- 9:50>
    
```

#### 6. Enter the Taper-Down Period

- Press **▲** or **▼** to select the period over which infusion will gradually decrease to end of infusion period.
- Press **ENTER**.

```

Taper-Down Period
  1 hrs 30 min
<Range: 00:00- 8:20>
    
```

#### 7. View the Calculated Rate

- Both the Plateau Rate and the KVO Rate will be displayed. (The KVO is 1/10 of the Plateau Rate or 5.0 ml/hr maximum.) Press **NEXT** to continue.

```

Plateau Rate
    117.6 ml/hr
KVO Rate   5.0 ml/hr
<Review Only>
    
```

#### 8. Clear the Milliliters Given

- Press **ENTER** if you wish to clear the total amount delivered since the time and date shown; even if the amount is zero, this updates the time and date markers.

```

Milliliters Given
    0.0 ml
since 01/08/96 10:35
Press ENTER to clear
    
```

## 9. Verify the Air Detector status

This screen will appear only if an Air Detector is installed.

- Make sure the setting is correct.

**NOTE:** If the Air Detector is not required, this screen will show whether it is turned on or off.

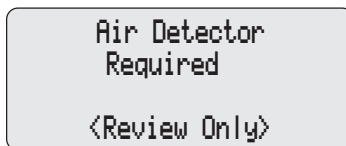

```
Air Detector
Required
<Review Only>
```

- Press **NEXT** to continue. If you need to correct the Air Detector setting, see the *Operator's Manual*.

## 10. Review the program

Press **NEXT** repeatedly to review the programming screens. If you need to reprogram a setting, press **NEXT** until the appropriate screen appears and change the setting as described in this section.

## TPN: Starting Daily Infusion

When a new administration set is attached to the pump at the beginning of infusion, the Reservoir Volume should be reset. This will also reset the infusion profile. To do this, follow the instructions on page 37 for attaching an administration set and answering yes to “Reset Reservoir Volume to ... ?” Then when you start the pump, delivery will begin at the start of the infusion period (illustrated below).

**NOTE:** Whenever the Reservoir Volume is reset, the infusion profile is also reset so the infusion will start at the beginning.

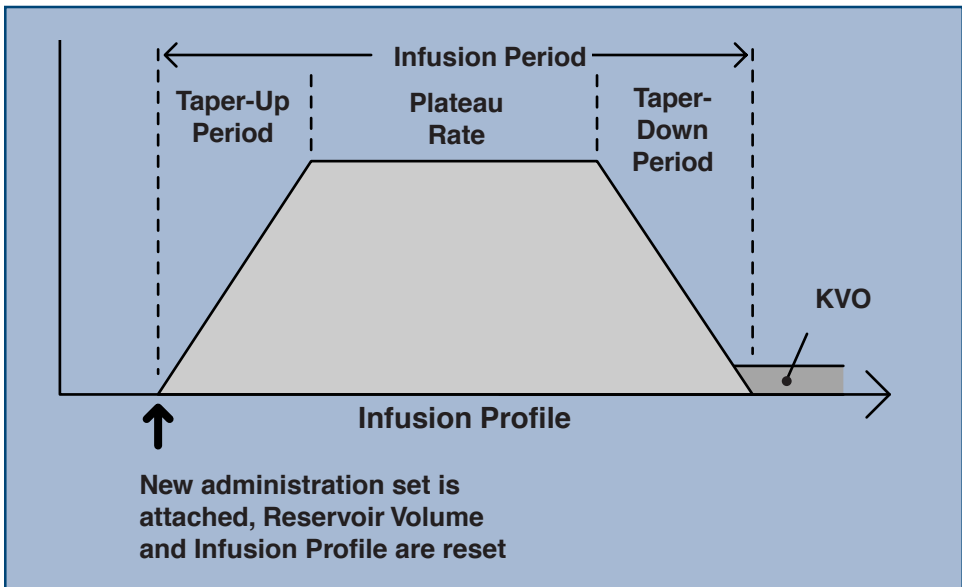



## Intermittent Cycle Graph and Programming Screens

The Intermittent delivery mode delivers a specified dose volume over a specified duration. You may repeat the dose in a cycle of up to 96 hours. The KVO feature allows you to deliver a minimal amount of drug between doses to maintain catheter patency. You may also delay the start of delivery using The Next Dose Start Time feature.

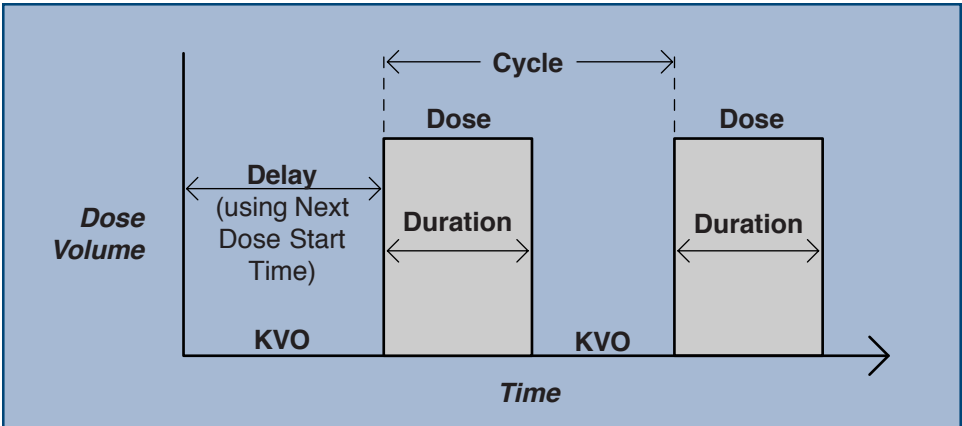

The following figure shows the programming screens in the Intermittent delivery mode:

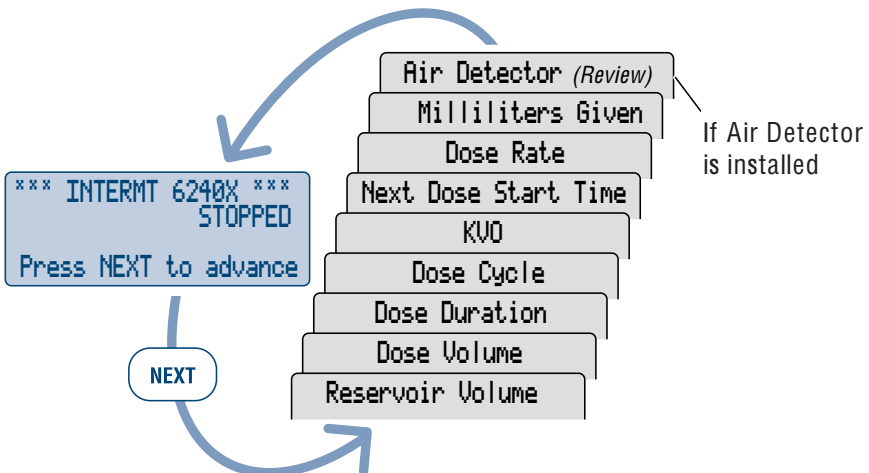



# Intermittent Programming

### ***Before programming:***

- ⤷ Stop the pump and change the Lock Level to LLO as described on page 9.
- ⤷ Select the Intermittent (INTERMT) delivery mode as described in Changing Delivery Modes on page 10. If the pump is already in the INTERMT delivery mode, you may select it again to clear all programming screens to their default settings.

### **1. Begin at the main screen**

- ⤷ Make sure the pump is in LLO.
- ⤷ Make sure INT and STOPPED appear on the main screen.
- ⤷ Press **NEXT** to begin.

```
*** INT 6240% ***
                STOPPED
Press NEXT to advance
```

### **2. Enter the Reservoir Volume**

- ⤷ Press **▲** or **▼** to select the volume of fluid in a filled reservoir. (If you do not wish to use the Reservoir Volume feature, scroll down to “Not In Use” located before 1.)
- ⤷ Press **ENTER**.

```
Reservoir Volume
  ⚡ 100.0 ml
<Range: 1 - 9999>
```

### **3. Enter the Dose Volume**

- ⤷ Press **▲** or **▼** to select the desired dose volume in milliliters.
- ⤷ Press **ENTER**.

```
Dose Volume
  ⚡ 50.0 ml
<Range: 0.1 - 1000>
```

### **4. Enter the Dose Duration**

- ⤷ Press **▲** or **▼** to select the time period over which dose will be delivered.
- ⤷ Press **ENTER**.

```
Dose Duration
  ⚡ 1 hrs 00 min
<Range: 00:09-24:00>
```



### 5. Enter the Dose Cycle

- Press **▲** or **▼** to select the time from the start of one dose to the start time of the next dose.
- Press **ENTER**.

```
Dose Cycle
  ⚡ 6 hrs 00 min
<Range: 01:05-96:00>
```

### 6. Enter the KVO Rate

- Press **▲** or **▼** to select the amount of drug delivered to maintain catheter patency.
- Press **ENTER**.

```
KVO Rate
  ⚡ 0.2 ml/hr
<Range: 0.0 - 10>
```

### 7. Enter the Next Dose Start Time

- Press **▲** or **▼** to select the date and time designated to start delivery of next dose (or “Immediate”).
- Press **ENTER**.
- Verify the start time shown on the screen and press **▲** if correct. If you need to re-enter the start time and date, press **▼**.

```
Next Dose Start Time
  ⚡ 20:00 2/21/96
<Range: See Help>
```

```
Start next dose in
3 hrs 27 min on
2/21/96 at 20:00?
Press Y or N
```

### 8. Verify the Dose Rate

- The pump automatically calculates the rate of dose delivery based on the volume and duration you entered. This screen is for review only; press **NEXT** to continue. (If the rate is 125 ml/hr or greater, a CADD-Prizm High Volume Administration Set must be used.)

```
Dose Rate
50.0 ml/hr
<Review Only>
```

### 9. Clear the Milliliters Given

- Press **ENTER** if you wish to clear the amount given; even if the amount is zero, this updates the time and date markers.

```
Milliliters Given
0.0 ml
since 01/08/96 10:35
Press ENTER to clear
```



### 10. Verify the Air Detector status

*This screen will appear only if an Air Detector is installed.*

- Make sure the setting is correct.

**NOTE:** *If the Air Detector is not required, this screen will show whether it is turned on or off.*

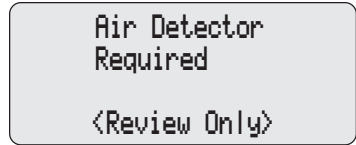

- Press **NEXT** to continue. If you need to correct the Air Detector setting, see the *Operator's Manual*.

### 11. Review the program

Press **NEXT** repeatedly to review the programming screens. If you need to reprogram a setting, press **NEXT** until the appropriate screen appears and change the setting as described in this section.





## INTERMT: Stopping the Pump During the Cycle

Stopping the pump **during the KVO** will not affect the start time of subsequent doses.

Stopping the pump **while a dose is in progress** will shift all subsequent doses by the amount of time the pump is stopped (illustrated below).

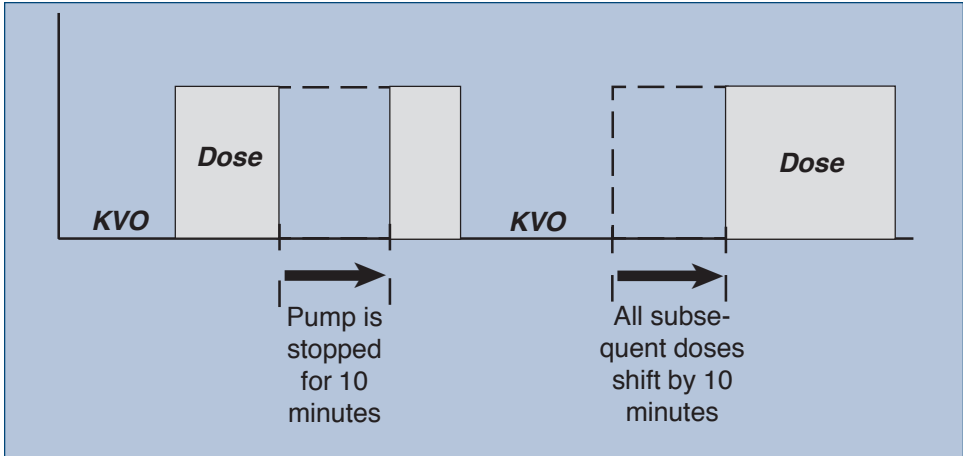

If you wish to make up for the lost time in the cycle, **it is recommended that you wait until the current dose is completed**. To determine the amount of time remaining in the current dose, use the Time Remaining Option (described on page 34). Then stop the pump, change to Lock Level 0, and reprogram the Next Dose Start Time (described on page 34).



### Time Remaining

This option allows you to view the time remaining in the current dose cycle if one is being delivered and the time remaining in the cycle. The pump may be running or stopped and in any lock level.

1. Press **OPTIONS**.

If necessary, press **▲** or **▼** until “**Time Remaining**” appears. Then press **ENTER**.

```
Options Menu
⚡ Time Remaining
Press ▲ or ▼ or ENTER
```

2. “Dose” shows the number of hours and minutes remaining in the dose that is currently being delivered.

```
Time Remaining
Dose      0 hrs 30 min
Cycle     5 hrs 30 min
```

“Cycle” shows the number of hours and minutes remaining in the current cycle (the time that must elapse until the next dose starts).

**NOTE:** If dashes appear in place of times, the start of the dose has been delayed by the Next Dose Start Time, and fluid is being delivered at the KVO rate (if programmed).

```
Time Remaining in:
Dose:   -- hrs -- min
Cycle:  -- hrs -- min
NEXT to continue
```

### Changing the Next Dose Start Time

If you wish to reset the cycle, stop the pump during KVO, change to LL0, and reprogram the Next Dose Start Time.

**NOTE:** The Next Dose Start Time cannot be changed in LL1.

If a dose has been stopped in progress and you wish to cancel the current dose and reset the cycle, make sure the pump is in Lock Level 0. The Next Dose Start Time screen should show “Interrupted.” Reprogram the Next Dose Start Time. This will cancel the remainder of the dose, and the next cycle will start at the time you selected.

### Resuming the Dose

To resume delivery of a dose that has been stopped in progress, simply restart the pump.

## Removing a Used Reservoir or Administration Set

**WARNING:** Always close the fluid path tubing with the clamp before removing the reservoir or administration set from the pump to prevent unregulated gravity infusion, which could result in death or serious injury to the patient.

1. Close the tubing clamp.
2. If the cassette is locked, insert the key and turn the lock clockwise one-quarter turn until it stops. (The mark on the lock will line up with open dot.)

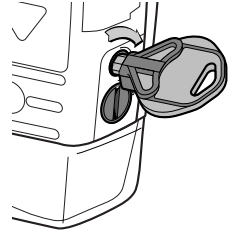

3. Use a coin or the side of the key to unlatch the cassette (the part of the reservoir or administration set that attaches to the pump). Insert the coin or the side of the key into the slot and turn clockwise until the latching button pops out. (The mark on the latch will line up with open dot.)

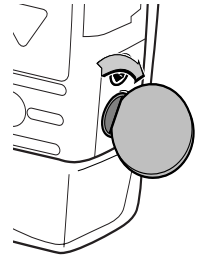

4. Remove the cassette hooks from the pump hinge pins.



## Attaching a New Reservoir or Administration Set

Refer to the instructions for use supplied with the reservoir or administration set for information on filling the reservoir, attaching a CADD® Extension Set with Anti-Siphon Valve or an Add On Anti-Siphon Valve, and preparing the product for use.

*The following sterile, single use products are compatible with the CADD-Prizm pump:*

- MEDICATION CASSETTE™ reservoir (50 or 100 ml), used with the CADD® Extension Set with Anti-Siphon Valve
- CADD® Administration Set with integral or add-on anti-siphon valve, for rates up to 125 ml/hr
- CADD-Prizm® High Volume Administration Set with add-on anti-siphon valve for rates up to 350 ml/hr (not for use in PCA delivery mode)

Rates above 125 ml/hr require a CADD-Prizm® High Volume Administration Set. Rates above 250 ml/hr also require an AC Adapter or a Power Pack.

*When you attach a reservoir or administration set, the pump's screens will lead you through the following steps:*

- verifying the type of cassette
- resetting the Reservoir Volume (if the reservoir volume has counted down)
- priming the fluid path (if the lock level is LL0 or LL1)
- changing the lock level (if AutoLock is not in use and the lock level is LL0)
- starting the pump

**CAUTION: If you are using a MEDICATION CASSETTE reservoir in which the medication is frozen, thaw at room temperature only. Do not heat in a microwave oven as this may damage the reservoir and cause leakage.**

**To attach the new reservoir or administration set**

1. Clamp the tubing. Insert the cassette hooks into the hinge pins on the pump.
2. Place the pump upright on a firm, flat surface. Press down so the cassette fits tightly against the pump.

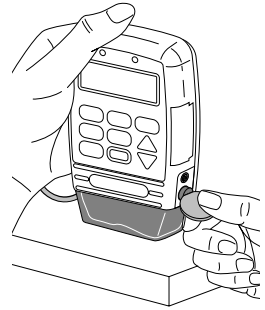

3. Insert a coin or the side of the key into the latch button, push in, and turn counterclockwise until the mark on the latch lines up with the solid dot and you feel the button click into place.

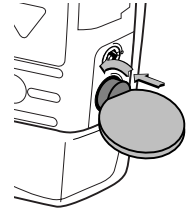

4. If appropriate, insert the pump key into the lock and turn counterclockwise until the white mark lines up with the solid dot.

Press **NEXT**.

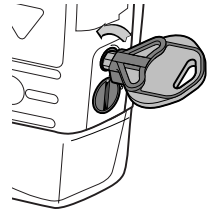

**NOTE:** In the **PCA delivery mode**, The cassette **must be locked** in order to start the pump.

**WARNING:** It is essential that you attach the cassette properly. When you attach the cassette properly, the marks on the latching button and the lock (if applicable) line up with the solid dots on the side of the pump. If you do not attach the cassette properly, unregulated gravity infusion of medication from the reservoir or a reflux of blood may result, which could result in death or serious injury to the patient. To protect against unregulated gravity infusion that can result from an improperly attached reservoir, a CADD Extension Set with Anti-Siphon Valve or a CADD Administration Set with either an integral or an Add On Anti-Siphon Valve must be used.

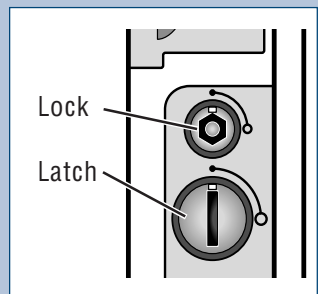

5. Gently twist and pull on the cassette to make sure it is firmly attached.

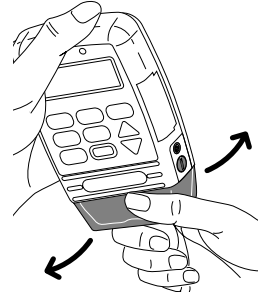

6. If “Reset Reservoir Volume to...?” appears,
  - Press **Y** to reset Reservoir Volume to the value shown, or
  - Press **N** to retain the current value.

Reset Reservoir  
Volume to 100.0 ml?  
Press Y or N

**NOTE:** If this screen does not appear, Reservoir Volume may already be reset.

If this message appears, the pump is in the TPN delivery mode and Reservoir Volume is not in use. Press **Y** to reset the infusion profile.

Reset Infusion  
Profile?  
Press Y or N

7. If you have reset the Reservoir Volume and the pump is in the TPN delivery mode, “Infusion Profile has been reset” will also appear.

Infusion Profile  
has been reset

Go to the next page.



## Priming the Tubing and Connecting to the Patient

If the lock level is LLO or LL1 when you attach a cassette, “Prime Tubing?” will appear in the sequence of screens. Prime the tubing *before* connecting it to the patient’s infusion set or indwelling catheter.

**NOTE:** *If you are not changing the cassette but wish to prime the fluid path, you may use the Prime Option. To prime, select Prime from the Options Menu, then follow the steps below, beginning with step 2.*

**WARNING:** *Do not prime the fluid path with the tubing connected to a patient as this will result in over delivery of medication, which could cause injury to the patient.*

### To prime the tubing and connect to the patient

- When “Prime Tubing?” appears, press .
  - Make sure the tubing is disconnected from the patient and the tubing clamp is open.
  - Press and hold the  key until the tubing is fully primed or until priming stops.
- NOTE:** *Fluid delivered during priming is subtracted from the Reservoir Volume, but is not added to the Given screen since this fluid is not delivered to the patient.*
- If the tubing is not yet fully primed, press  and repeat step 3.

When the tubing is fully primed, press  to exit priming.

Prime Tubing?

Press Y or N

Prime Tubing?

Press Y or N

Disconnect tubing  
from patient  
Open clamps  
Hold Y to prime

Priming...  
0.1 ml

Hold Y to prime

Continue Priming?

Press Y or N

5. If an Air Detector is in use, open the Air Detector door and thread the tubing through the groove.

**WARNING: When the Air Detector is not installed, or is installed but turned off, the pump will not detect air in the fluid path. It is recommended that you periodically inspect the fluid path and remove any air to prevent air embolism. Air embolism could cause serious injury to the patient.**

6. Close the door, making sure the tubing does not get pinched or kinked.
7. Connect to the patient's infusion set or indwelling catheter.

**WARNING: Ensure that the entire fluid path is free of all air bubbles before connecting to the patient to prevent air embolism. Air embolism could cause serious injury to the patient.**

**NOTE:** If the fluid path contains an air eliminating filter, it is acceptable for air bubbles to be present on the vent side of the filter.

8. If AutoLock is in use, or if the pump is in LL1 or LL2, "Start the Pump?" will appear; go to step 9.

If AutoLock **is not** in use and the lock level is LL0, the pump will prompt you to manually change the lock level; the screen at right will appear.

**Press  and follow the steps for changing the lock level (see page 9).**

9. Make sure the fluid path is free of air and the set is attached to the patient. When "Start the pump?" appears, press .

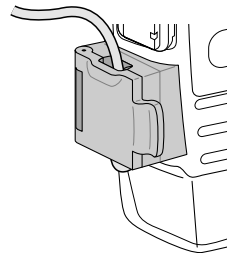
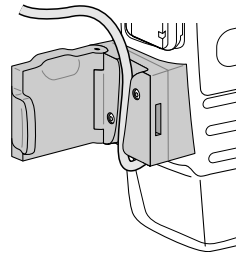

AutoLock not in use.  
Change Lock Level  
from LL0?  
Press Y or N



## Resetting the Reservoir Volume

Normally, when you attach a cassette onto the pump as described on page 36, a series of messages lead you through resetting the Reservoir Volume, priming the tubing, (except in LL2), and starting the pump.

You can, however, reset the Reservoir Volume without changing the cassette using the Reservoir Volume programming screen. The pump may be in any lock level.

**NOTE:** In the **TPN delivery mode**, resetting the Reservoir Volume also resets the infusion profile so delivery will start at the beginning of the infusion period when you start the pump.

### Resetting Reservoir Volume without changing the cassette

1. Stop the pump.
2. Press **NEXT** to display the Reservoir Volume screen.
3. Press **ENTER**.
4. If this message appears, press **▲** to reset the Reservoir Volume. (If this message does not appear, the Reservoir Volume may already be reset.)

If this message appears, the pump is in the TPN delivery mode and Reservoir Volume is not in use. Press **▲** to reset the Infusion Profile.

5. If you have reset the Reservoir Volume and the pump is in the TPN delivery mode, you will also see “Infusion Profile is being reset.”

Reservoir Volume  
29.2 ml  
  
<Range: Limited>

Reset Reservoir  
Volume to 100.0 ml?  
  
Press Y or N

Reset Infusion  
Profile?  
  
Press Y or N

## Overview: Accessing Options

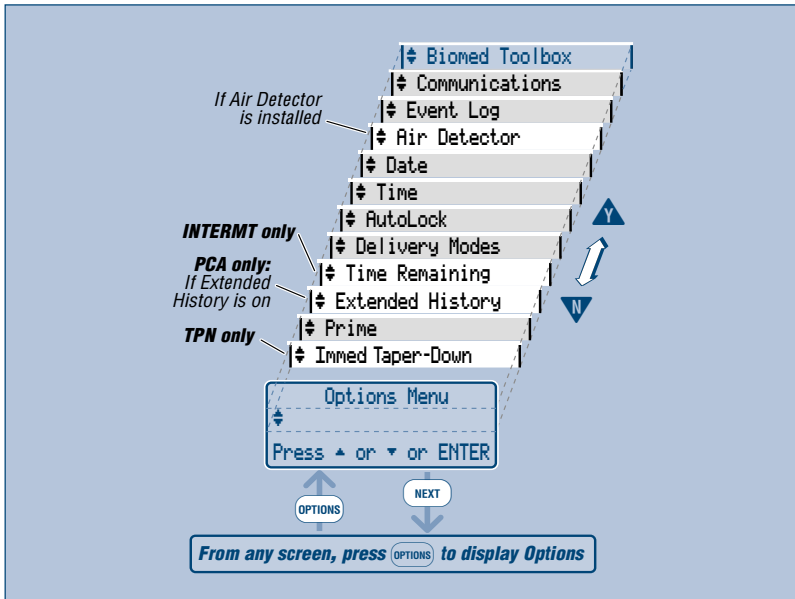

The Options menu allows access to other pump features and settings. The availability of an Option may depend on the pump’s delivery mode, lock level, Biomed Toolbox settings, the presence of an Air Detector, and whether the pump is running or stopped. (See the *Operator’s Manual* for more detailed information. For more information about the Communications option, refer to the product literature supplied with the CADD-Ambassador™ Pump Communications System or CADD-Diplomat™ PC Communications System.)

### To access Options

1. Start at any screen and press **OPTIONS**.
2. Use **▲**, **▼** or **OPTIONS** to page through the Options. To select an Option, make sure it is displayed on the Options Menu and press

The **◆** symbol means you may use the **▲** or **▼** key to see more Options.

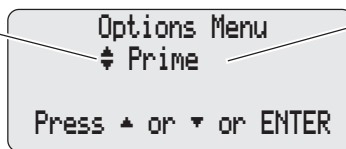

Options appear here. In this example, the “Prime” option is shown. To select the option shown, press ENTER. To see other options, press **▲**, **▼** or **OPTIONS**.

3. To exit the Options Menu, press **NEXT** until you return to the main screen.

## Immediate Taper-Down: TPN

This option is available in the **TPN delivery mode only**. It allows you to stop infusion early by immediately tapering down. If the pump is in LL0 or LL1, the Taper-Down Period can be changed from its originally programmed value, even if it is 0. You can select a Taper-Down Period that is equal to or less than the time remaining in the infusion profile. If the pump is in LL2, you can use the Immediate Taper-Down Option, but you cannot change the Taper-Down Period.

*To access the Immediate Taper-Down option:*

- The pump must be running
- The pump must be delivering at the plateau rate
- There must be at least 10 minutes left in the Infusion Period

## Prime

The Prime Option is used in all delivery modes to pump fluid through the fluid path to remove air bubbles prior to connecting to the patient. The pump must be stopped and in LL0 or LL1 to prime.

Fluid delivered with the priming feature is subtracted from the Reservoir Volume value, but is not added to the amount Given (since this fluid is not delivered to the patient). Priming is not allowed when the Reservoir Volume value is 0.0 ml.

To prime, select Prime from the Options Menu, then follow the steps on page 42, beginning with step 2.

## Time Remaining: Intermittent

This option is available in the **Intermittent delivery mode only**. It allows you to view the time remaining in the current dose if one is being delivered and the time remaining in the cycle. The pump may be running or stopped and in any lock level. See page 34 for instructions.

## Extended History, Viewing: PCA

The Extended History is available in the **PCA delivery mode only**. It allows you to view dose information for the past 48 hours, including doses given and attempted, and the amount delivered. The pump may be running or stopped and in any lock level. You may select from two types of views:

- **Patient Review** gives a summary of the pump's current settings, the number of doses given and attempted, and the amount delivered, starting at a date and time you specify.
- **Doses Hour by Hour** allows you to page back through summaries for each one hour period, showing the number of doses given and attempted.

Both views show dose information for the past 48 hours, unless a New Patient Marker has been added, or the Units, Time, or Date have been changed. Dose information previous to any of these events will not appear.

*Once you have selected the Extended History Option:*

1. Press **▲** or **▼** to select “**Patient Review**” or “**Doses Hour by Hour**,” then press **ENTER**.

**Follow the instructions for the appropriate screen.**

```
Extended History
┆ Patient Review
Press ▲ or ▼ or ENTER
```

### **Patient Review**

2. Press **▲** or **▼** to select the start time and date, then press **ENTER**.

**NOTE:** All start times begin on the hour.

```
Review Start Time
┆ 10:00 06/07/96
```

```
Press ▲ or ▼ or ENTER
```

3. The first screen, “Pump Settings 1” will appear. Press **▲** to page forward through the Patient Review screens. Press **▼** to page backward.

```
Patient Review
┆ Pump Settings 1
Res Vol      60.0 ml
```



4. When finished, press  to return to the Extended History screen.

**NOTE:** An asterisk (\*) next to a value indicates that it applies only to the selected time period; it may not match the corresponding value in the programming screen. For example, “\*Given” only reflects doses given during the selected time period, and may not match the “Given” value on the Dose Counters screen.

### Doses Hour by Hour

5. After you select Doses Hour by Hour, the number of doses given and attempted during the *current hour* will appear.

Doses Hour by Hour	
‡10:00-10:59	06/08/96
*Given	1
*Attempted	2

- Press  to page back through hours.
- Press  to page forward.

6. When finished, press  to return to the Extended History screen.

## Changing Delivery Modes

The CADD-Prizm pump contains four delivery modes: PCA, CONTIN, TPN, INTERMT. (The pump also contains a Communications mode; for more information, refer to page 47 and the product literature accompanying the CADD-Ambassador™ Pump Communications System or CADD-Diplomat™ PC Communications System.) To change the delivery mode, see page 10. When you change the mode, the program will revert to the default settings, and the Event Log will clear. Therefore, you may wish to print the Event Log before changing the mode. Other Options settings will not be affected.

## AutoLock

The **AutoLock** Option is available in all delivery modes. It automatically changes the lock level from LL0 to **LL1 or LL2** when the pump is started, instead of requiring you to manually change the lock level before giving the pump to the patient. AutoLock may be set to LL1, LL2, or Not In Use.

## Time

The **Time** Option shows the time of day in 24-hour (military) time according to the pump's internal clock. The clock is powered by a separate, internal battery which retains the time even when the 9 volt battery is removed. The time is used to record the time of events in the Event Log.

## Date

The **Date** Option should reflect the current date. This feature is used to record the date of events in the Event Log.

## Air Detector On/Off

The **Air Detector** Option controls whether the Air Detector is turned on or off. This option appears in the menu only if an Air Detector is installed on the pump and is not required. (A setting in the Biomed Toolbox controls whether an Air Detector is required. If the Air Detector is required, you are not allowed to turn it off and this option will not appear in the menu.)

For certain therapies, it may be desirable to turn off the Air Detector (for example, for epidural infusion or subcutaneous infusion).

***WARNING: When the Air Detector is installed but turned off, the pump will not detect air in the fluid path. It is recommended that you periodically inspect the fluid path and remove any air to prevent air embolism.***

## Event Log, Viewing

The **Event Log** records the following types of events: dose delivery, alarms, errors, power source changes, cassette changes, changes to pump programming or settings. The pump records the date and time of each event, and lists events in order starting from the most recent through the last 500 events or the last delivery mode change.

The pump may be running or stopped and in any lock level to view the Event Log.

## Communications

The Communications Option allows you, the clinician, to use the telephone line to connect to a patient's CADD-Prizm® pump. This allows you to program a patient's pump or review screens from a remote location. Once a connection is established, the patient's screens appear on your pump, so you can view, troubleshoot, or program the pump as though you are actually working with the patient's pump. Meanwhile, the patient's pump displays a "Please Wait" message so he or she cannot see the screens you are working with. A connection can be established regardless of whether the patient's pump is running, stopped, or sounding an alarm (except a pump error). Both you and the patient must have a CADD-Ambassador™ Pump Communications System to use this option.

The Communications Option also allows you to establish a connection directly with a CADD-Prizm® pump through your own laptop or personal computer. You also may establish a remote connection with a patient's pump via modem through your laptop or personal computer. You must have a CADD-Diplomat™ PC Communications System and your patient must have a CADD-Ambassador™ Pump Communications System to use this option.

## Biomed Toolbox

The Biomed Toolbox is used to customize certain pump configurations that are not frequently changed, for example, customized concentrations. The Biomed Toolbox is accessible only when the pump is stopped and in Lock Level 0.

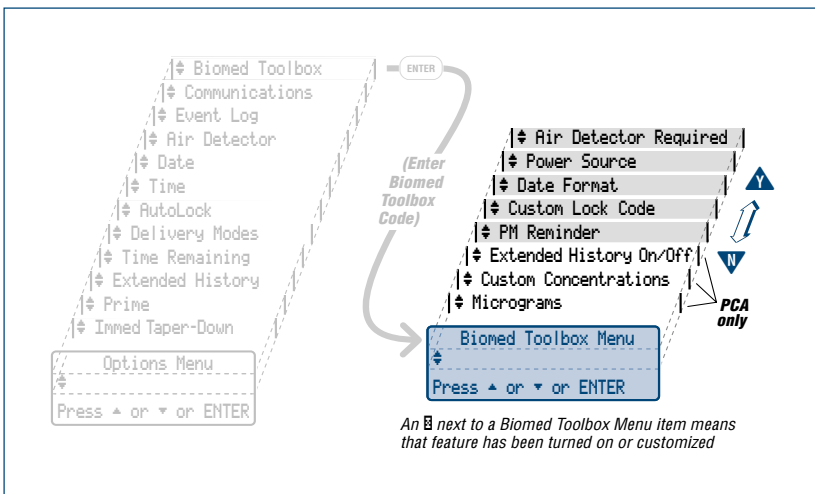

## Printing Reports

Reports may be printed from the CADD-Prizm® VIP pump either by using an interface cable and printer or CADD-Diplomat PC Communications System.

### ***Through a Printer***

An Interface Cable and printer may be purchased separately for use with the CADD-Prizm VIP pump. Please refer to the Instructions for Use that are included with the Interface Cable for details on how to print reports.

### ***Through the CADD-Diplomat™ PC Communications System***

The CADD-Diplomat PC Communications System may be purchased separately for use with the CADD-Prizm VIP pump. Through this system, reports are printed from the pump via a personal computer using the CADD-Diplomat PC Communications System. Please refer to the User Information Guide that is included with the CADD-Diplomat PC Communications System for instructions on how to print reports.

## Power Pack or AC Adapter

You can attach an alternate source of power to the pump, such as the CADD External Power Source (EPS) System Power Pack (reorder number 21-3801) or AC Adapter. The pump **must** also contain a functional 9 volt battery as a backup. Otherwise, the pump will not start.

Before using the power pack, refer to the *CADD External Power Source (EPS) System Instructions for Use* supplied with the power pack for instructions on equipment setup, system operation, specifications, and warnings.

### **CAUTIONS:**

- ***Do not use the battery adapter supplied with the EPS system. Although the battery adapter is used with other CADD pumps, the CADD-Prizm pump's battery compartment is not designed to hold the battery adapter. A 9 volt battery must be installed instead.***
- ***Do not allow the power pack to hang from a pump mounted on an IV pole. This may result in damage to the power pack.***



### To attach the Power Pack or AC Adapter

1. Open the cover for the Power jack.
2. Line up the red mark on the power pack or AC adapter connector with the red mark on the pump. Push the connector in until it clicks.

**NOTE:** The connector may or may not be supplied with the grip shown in this illustration.

3. If using an AC adapter, plug the other end into a 3-pronged wall outlet.

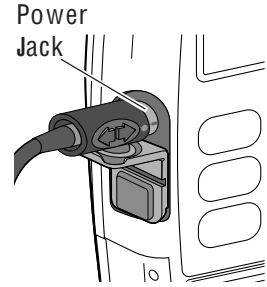

### To detach the Power Pack or AC Adapter

**CAUTION:** To avoid damaging the connector or cable, do not use excessive force or instruments such as pliers to remove the connector from the pump.

1. Grasp the collar on the connector
2. Pull the connector back using a straight, steady motion.  
DO NOT twist or turn the connector.

## Remote Dose Cord

In the PCA delivery mode, a Remote Dose Cord may be attached to the pump so the patient can start a Demand Dose by pressing either the Remote Dose Cord button or the DOSE key.

**NOTE:** The Remote Dose Cord is used only for starting Demand Doses. It is not associated with pump Communications.

#### CAUTIONS:

- ⓘ **Do not place the Remote Dose Cord where the button might accidentally be pushed. Accidentally pushing the button may deliver an inadvertent Demand Dose.**
- ⓘ **Do not use the Remote Dose Cord to pick up or carry the pump. Using the cord in this manner could damage the pump or cord.**
- ⓘ **To avoid damaging the connector or cord, do not use excessive force or instruments, such as pliers, to remove the Remote Dose Cord from the pump.**

**To attach the Remote Dose Cord:**

1. Open the cover for the Data In/Out jack.
2. Line up the red mark on the Remote Dose Cord connector with the red mark on the pump. Push the connector in until it clicks.

**NOTE:** The cord may or may not be supplied with the grip shown in this illustration.

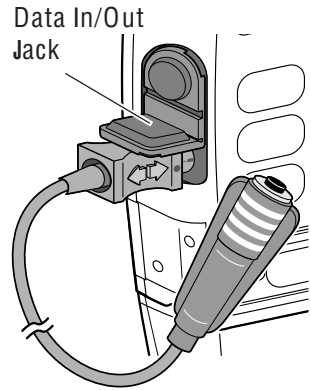

**To detach the Remote Dose Cord:**

1. Grasp the collar on the connector.
2. Pull the connector back using a straight, steady motion. DO NOT twist or turn the connector.

## Security Shell

The Security Shell helps prevent access to the medication. The Security Shell encloses the IV bag or sterile vial with injector (syringe) and locks the pump in such a way that the medication reservoir is inaccessible, but the pump keypad, battery compartment, and jacks are accessible.

Follow the instructions on page 36 for attaching the administration set to the pump before installing the components into the Security Shell.

**WARNING:** If the Security Shell is dropped, immediately stop the pump and remove it from the Security Shell. Make sure there is no damage to any of the components, and that the IV bag or syringe is installed properly. Damage to the IV bag or syringe could result in upstream occlusion, nondelivery of drug, and/or air embolism, which could cause death or serious injury.

### IV bag: Hang from the post

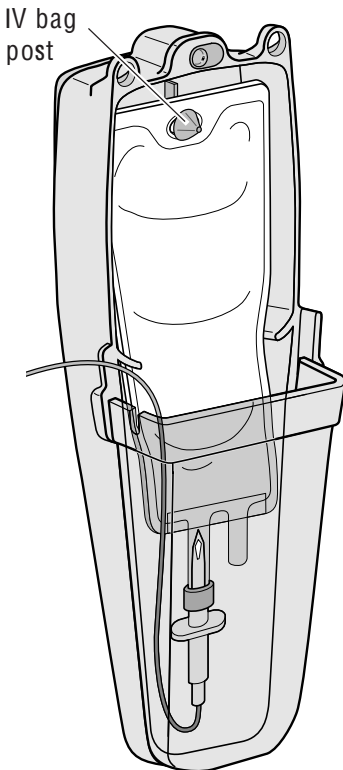

### Syringe: Slide end of plunger into the syringe holder.

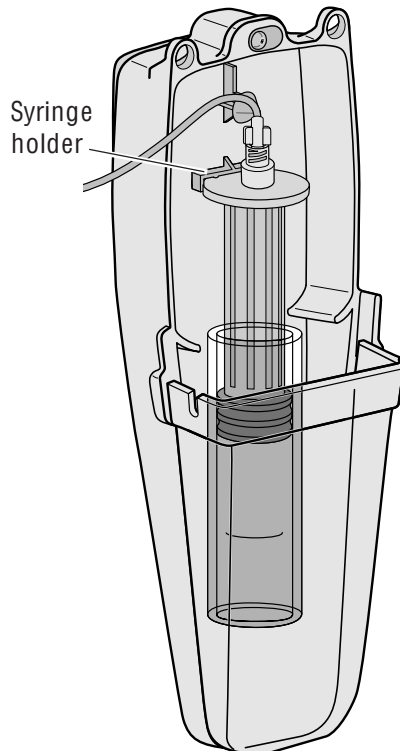

## Installing the fluid bag or syringe and pump

1. If you are using an IV bag, first insert the end of the bag spike into the bottom of the Security Shell, then hang the bag from the post inside the Security Shell (previous page, left side); or,

If you are using a syringe, slide the end of the plunger into the syringe holder inside the Security Shell (previous page, right side).

2. Fit the pump onto the Security Shell, cassette end first. Make sure the tubing leading from the IV bag or syringe to the pump fits completely inside the Security Shell.

**CAUTION: Do not pinch the tubing between the pump and Security Shell; this may result in an alarm and/or nondelivery of fluid.**

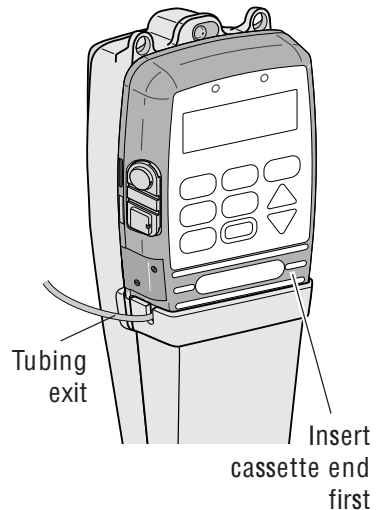

3. Hold the pump firmly against the Security Shell. Insert the key into the lock on the back of the Security Shell and turn it counterclockwise until the black mark lines up with “Locked.” Make sure the pump is firmly locked into place.

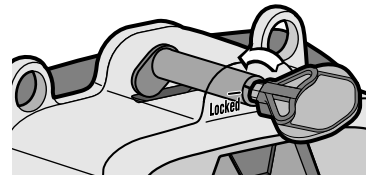

## Removing the pump and the fluid bag or syringe

1. Insert the key into the lock. Turn the key clockwise until the pump unlocks from the Security Shell.
2. Remove the pump and the fluid bag or syringe.

## Polemount Bracket

The Polemount Bracket allows you to mount a CADD-Prizm® pump to an IV pole. It is designed to attach directly to the back of a CADD-Prizm® pump or Security Shell.

### **To attach the Polemount Bracket**

1. Place the bracket around the IV pole at the desired height. Clamp the bracket firmly to the pole by turning the knob clockwise.
2. Match the tabs on the Polemount Bracket with the notches on the back of the pump or Security Shell.
3. Slide the pump or Security Shell downward until you hear it click into place.

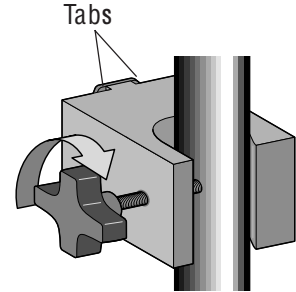

### **To remove the Pump or Security Shell from the Polemount Bracket**

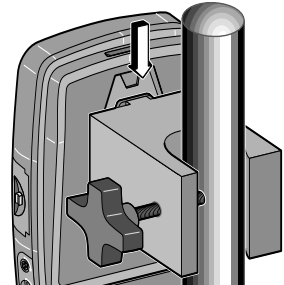

1. Push in and hold the black button on the side of the Polemount Bracket.
2. Lift the pump or Security Shell up and off of the bracket.



## Alarms and Messages, Alphabetical List

A more detailed list of alarms and messages is included in the *Operator's Manual*.

<b>Message</b>	<b>Corrective Action</b>
9 volt Battery Depleted / install good battery	<p>Install a fresh 9 volt battery. The pump will not start with a depleted 9 volt battery. A good battery must always be installed even when an external source of power is connected.</p> <p><b>NOTE:</b> <i>This message may appear when you install a fresh battery while an external source of power is connected. Remove and reinstall the battery to cancel this message, then restart the pump if necessary.</i></p>
9 volt Battery Low	<p>The 9 volt battery is low but the pump is operable. Change the 9 volt battery soon.</p> <p><b>NOTE:</b> <i>This message may appear when you install a fresh battery while an external source of power is connected. Remove and reinstall the battery to cancel this message.</i></p>
Air Detector is being turned on	<p>The Air Detector is being turned on automatically because the pump is powering up in Lock Level 0. Use Options if you wish to turn off the Air Detector.</p>
Air in line detected / Pump will not run	<p>The Air Detector has detected air in the fluid path; the fluid path may contain air bubbles, or the tubing may not be threaded through the Air Detector. Press <b>(NEXT)</b> to silence the alarm, then:</p> <ul style="list-style-type: none"> <li>➤ Make sure the tubing is threaded properly.</li> <li>➤ If the fluid path contains air bubbles, close the clamps and disconnect the fluid path from the patient. Then follow the instructions for removing air using the Prime Option on page 43.</li> </ul>

<b>Message</b>	<b>Corrective Action</b>
AutoLock is changing Lock Level to (LL1 or LL2)	No action is necessary; the AutoLock feature is automatically changing the pump's lock level to the level shown.
Cassette not attached/ pump will not run	The pump will not start without a cassette attached. Make sure a cassette is attached properly. Then start the pump.
Cassette Unlocked	<b>PCA:</b> The PCA delivery mode requires the cassette to be locked onto the pump before it can be started. If an alarm is sounding, press  to silence the alarm. Lock the cassette, then start the pump.
<Custom>	On a programming screen, this indicates that available settings have been customized. On a screen in which a code is entered, this message indicates the pump's Lock Level Code has been customized.
Error Detected / E (code)	A pump fault has occurred. Close the tubing clamp and remove the pump from use. Contact Customer Service to return the pump for service.
High Pressure	The pump has detected high pressure, which may be resulting from a downstream blockage, kink in the fluid path, or a closed tubing clamp. Remove the obstruction to resume operation. Or, press  to stop the pump and silence the alarm for 2 minutes, then remove the obstruction and restart the pump.
High Volume Admin Set not Supported in this version of PCA / Remove admin set	The CADD-Prizm® High Volume Administration Set cannot be used with the PCA delivery mode. You must remove the set to continue.

<b>Message</b>	<b>Corrective Action</b>
Power Pack Depleted / Change Power Source	The power pack is depleted and unable to support pump operation. The 9 volt battery is supplying power. Recharge the power pack with the AC Adapter.
Prev. Maint. Reminder (date)	Your institution may have established a maintenance program for the pump and preventive maintenance is due. Refer to your institution's policy.
Printing Failure / Check printer & cable	Printing has stopped. The paper may be out or jammed, the printer may have lost power, or the printer may be off-line. Press <b>◻NEXT</b> to silence the alarm and refer to the printer manual to correct the problem. Then remove and reattach the cable and repeat printing.
Printing Stopped / Print Again?	During printing, <b>▼</b> was pressed, signalling printing to stop. To start over, press <b>▲</b> . To exit printing, press <b>▼</b> .
Range: Limited	This message appears on rate, dose, or Reservoir Volume screens when the pump is in LL1. It indicates that the range of programmable values is limited by the value programmed in LL0 (i.e. you cannot increase the value beyond what was programmed in LL0).
Reservoir Volume is zero	The Reservoir Volume has reached 0.0 ml. Press <b>◻NEXT</b> to stop the alarm. Then install a new reservoir if appropriate.
Reservoir Volume Low	The Reservoir Volume value is low, indicating that the level of fluid in the reservoir is low. Prepare to install a new reservoir.



<b>Message</b>	<b>Corrective Action</b>
<b>Upstream Occlusion (Model 6101 only)</b>	Fluid is not flowing from the reservoir to the pump. Check for a kink, a closed clamp or an air bubble in the tubing between reservoir and pump. Press <b>STOP START</b> to stop the pump and silence the alarm for two minutes, then remove the obstruction and press <b>NEXT</b> to restart the pump.
Wrong Cassette	The pump detects the cassette is damaged, attached improperly, or incompatible with the pump. Close the tubing clamp. Make sure the cassette is attached properly. Then open the clamp and restart the pump. If the alarm persists, you may need to replace the cassette.



This guide pertains **only** to the Deltec CADD-Prizm® VIP (Variable Infusion Profile) Model 6100 and 6101 ambulatory infusion pump and the following delivery modes:



**PCA**  
**PCA 6210**

(all revision letters)



**Continuous**  
**CONTIN 6220**

(all revision letters)



**TPN**  
**TPN 6230**

(all revision letters)



**Intermittent**  
**INTERMT 6240**

(all revision letters)

**NOTE: This is intended as an operating guide only.** For detailed instructions, specifications, warnings, warranty, and additional information on operating the CADD-Prizm pump, please refer to the **Operator's Manual** supplied with the product.

**WARNING:**

- **Avoid dropping the pump or hitting the pump against a hard surface, as this could cause the cassette to become detached, the battery cover to become detached or loose, or the liquid crystal display (LCD) to become damaged. If the cassette becomes detached, an uncontrolled flow of medication from the reservoir or a reflux of blood may result, which could result in death or serious injury to the patient. If the battery door becomes detached or loose, the battery will not be properly secured; this may result in loss of power, nondelivery of drug, and, depending on the type of drug being administered, death or serious injury. Damage to the LCD could result in improper display of data.**
- **If the pump is dropped or hit, inspect the pump to ensure that the cassette did not become detached and the battery cover did not become dislodged. Inspection should include closing the clamp on the tubing, detaching the pump and inspecting the hinges, and checking the battery door to ensure they are not broken. The pump should also be powered up and the display should be inspected for any stripes. If there appears to be damage, the patient should be instructed to immediately contact his or her health care provider, the pump should be taken out of service, and Deltec's Customer Service department should be contacted for return authorization. If there appears to be no damage, reattach the cassette following the instructions in the Operator's Manual.**
- **To prevent the uncontrolled flow of medication, use a CADD Extension Set with Anti-Siphon Valve, a CADD Administration Set with integrated anti-siphon valve, or a CADD Administration Set with an attached Add On Anti-Siphon Valve.**
- **The use of a Deltec Pump Pouch is recommended. If the pump is dropped or inadvertently hit against a hard surface, the Pump Pouch is designed to minimize the need for servicing.**



## Table of Contents

<b>Section 1</b>	<b>General Description and Basic Operations</b>	<b>1</b>
	Description of the CADD-Prizm® VIP Pump .....	1
	Pump Diagram .....	2
	Callout Descriptions .....	3
	Keypad .....	3
	Installing a Battery .....	5
	The Main Screen .....	6
	Getting Help Using the (?) Key .....	7
	Lock Level Table .....	8
	Changing the Lock Level .....	9
	Changing Delivery Modes .....	10
	Starting and Stopping the Pump .....	11
<b>Section 2</b>	<b>Pump Programming</b>	<b>12</b>
	<b>PCA Delivery Mode</b>	
	PCA Cycle Graph and Programming Screens .....	12
	PCA Programming .....	13
	PCA: Programming with Upper Limits, Adjusting Doses in Lock Level 1 .....	17
	PCA: Starting a Clinician Bolus .....	18
	PCA: Starting a Demand Dose .....	18
	PCA: Stopping a Demand Dose or Clinician Bolus .....	19
	<b>Continuous Delivery Mode</b>	
	Continuous Cycle Graph and Programming Screens .....	20
	Continuous Programming .....	21
	CONTIN: Programming with Upper Limits, Adjusting Rate in Lock Level 1 .....	23
	<b>TPN Delivery Mode</b>	
	TPN Cycle Graph and Programming Screens .....	24
	TPN Programming .....	25
	TPN: Starting Daily Infusion .....	28
	<b>Intermittent Delivery Mode</b>	
	Intermittent Cycle Graph and Programming Screens .....	29
	Intermittent Programming .....	30
	INTERMT: Stopping the Pump During the Cycle .....	33

Time Remaining .....	34
Changing the Next Dose Start Time .....	34
Resuming the Dose .....	34

**Section 3 Medication Reservoir or Administration Set 35**

---

Removing a Used Reservoir or Administration Set .....	35
Attaching a New Reservoir or Administration Set .....	36
Priming the Tubing and Connecting to the Patient .....	39
Resetting the Reservoir Volume .....	41

**Section 4 Options 42**

---

Overview: Accessing Options .....	42
Immediate Taper-Down: TPN .....	43
Prime .....	43
Time Remaining: Intermittent .....	43
Extended History, Viewing: PCA .....	44
Changing Delivery Modes .....	45
AutoLock .....	45
Time .....	46
Date .....	46
Air Detector On/Off .....	46
Event Log, Viewing .....	46
Communications .....	47
Biomed Toolbox .....	47

**Section 5 Accessories 48**

---

Printing Reports .....	48
Power Pack or AC Adapter .....	48
Remote Dose Cord .....	49
Security Shell .....	51
Polemount Bracket .....	53

**Section 6 Troubleshooting and Reference 54**

---

Alarms and Messages, Alphabetical List .....	54
--	----



# Deltec

SIMS Deltec, Inc., St. Paul, MN 55112 U.S.A.

**simS** SMITHS INDUSTRIES  
Medical Systems

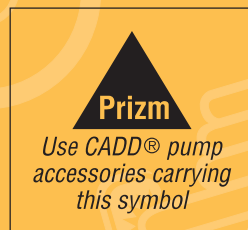

Deltec®, CADD® and CADD-Prizm® are registered trademarks of SIMS Deltec, Inc.

MEDICATION CASSETTE™ is a trademark of SIMS Deltec, Inc.

DURACELL® is a registered trademark of DURACELL INC.

ULTRALIFE® is a registered trademark of ULTRALIFE Batteries, Inc.

Covered by one or more of the following: U.S. Patent Nos. 4,559,038; 4,565,542; 4,650,469; 5,181,910; 5,338,157; 5,364,242; 5,485,408; 5,531,697; 5,531,698; 5,538,399; 5,540,561; 5,564,915; 5,567,136; 5,567,119; other patents pending.

©1998 SIMS Deltec, Inc. All rights reserved. Printed in U.S.A. 4/98 19822



# CLINICIAN INFORMATION

For Continuous, Intermittent, TPN or PCA Delivery

## CADD Prizm<sup>®</sup> VIP

Model 6100 and 6101

Ambulatory

Infusion

Pump



Continuous



Intermittent



TPN



PCA

**Deltec**

 **SMITHS INDUSTRIES**  
Medical Systems